



ANTONELLI  
ATELIER



ANTONELLI  
ATELIER

TOTAL DESIGN

by Silvano Del Guerra





TOP  
TATS  
DESIGN



Con il catalogo TOTAL DESIGN si completa l'offerta di Antonelli per gli spazi dell'abitare contemporaneo. Il nuovo programma modulare SYSTEMS, composto da elementi contenitori e boiserie, codifica, nel segno della collezione ANTONELLI ATELIER, la pluridecennale esperienza internazionale dell'azienda toscana nella realizzazione di soluzioni su misura. Living, dining, office, bedroom: infinite possibilità di composizione per contenere arredando con stile ogni ambiente.

The TOTAL DESIGN catalogue completes Antonelli's offer for contemporary living spaces. The new modular SYSTEMS program, consisting of container elements and boiserie, encodes, in the name of the ANTONELLI ATELIER collection, the decades-long international experience of the Tuscan company in the creation of customized solutions. Living, dining, office, bedroom: infinite composition possibilities to contain and furnish any environment with style.



# SYSTEMS



# NEW



## LIVING ROOM

System 01	12
System 02	20
System 03	22

## DINING ROOM

System 04	28
System 05	34
System 06	38

## OFFICE

System 07	42
System 08	50
System 09	52

## BEDROOM

System 10	68
System 11	74
System 12	80
System 13	82
System 14	90
System 15	94
System 16	104
Cameretta	114

## TECHNICAL SECTION

ELEMENTS	120
SAMPLES	152
	188

LIVING ROOM

LIVING ROOM









SYSTEM 01





**SYSTEM 01** è un sistema composto da parete porta tv e boiserie. La parete porta tv presenta struttura e schienali in OAK e dettagli in metallo finitura ROSE. Sottotop, pilastri e cassetti sono arricchiti con inserti in pelle ZENITH 627. Le ante laterali battenti in vetro curvato presentano all'interno illuminazione led e mensole in vetro trasparente.

La boiserie è composta da pannelli in legno con impiallacciatura in OAK e profili in metallo finitura ROSE. Preziosi dettagli come illuminazione led e inserti in pelle ZENITH 627 completano la pannellatura.

Al centro della stanza si trovano il divano componibile **GENTLEMEN** in tessuto ZEUS 02 e tavolino **KENDO** con top in vetro trasparente e base in legno curvato rivestita in pelle ZENITH 627.

Completa la zona il tappeto **RIA** effetto velluto. Davanti alla boiserie la consolle **THAI** in legno laccato MOKA OPACO con piano in laminam OSSIDO BRUNO e base in metallo finitura ROSE.

**SYSTEM 01** is a system consisting of a TV wall and boiserie. The TV stand has structure and backs in OAK and metal details in ROSE finish. Undertop, pillars and drawers are enriched with ZENITH 627 leather inserts. The hinged side doors in curved glass have internal led lighting and transparent glass shelves.

The boiserie is made up of wood panels with OAK veneer and ROSE finish metal profiles. Precious details such as LED lighting and ZENITH 627 leather inserts complete the paneling.

In the center of the room are the **GENTLEMEN** modular sofa in ZEUS 02 fabric and **KENDO** coffee table with transparent glass top and curved wooden base covered in ZENITH 627 leather.

The area is completed by the velvet-effect **RIA** rug. In front of the boiserie, the **THAI** console in MATT MOKA lacquered wood with BROWN OXIDE laminam top and ROSE finish metal base.











La parete componibile porta tv SYSTEM 02 presenta struttura e schienali in legno laccato AVORIO OPACO e dettagli in metallo finitura TITANIO. Sottotop e pilastri sono arricchiti con inserti in pelle ZENITH 634. Le ante laterali battenti in vetro curvato presentano all'interno illuminazione led e mensole in vetro trasparente.

The SYSTEM 02 modular TV wall panel has structure and backs in MATT AVORIO lacquered wood and details in TITANIUM finish metal. Undertop and pillars are enriched with ZENITH 634 leather inserts. The hinged side doors in curved glass have internal led lighting and 6/8 mm thick transparent glass shelves.









La flessibilità del componibile **SYSTEM 03** è evidenziata con la presenza del modulo angolare a vetro ed un grande vano centrale di cm 180 per la tv. La struttura è in finitura **EBONY OPACO** e dettagli in metallo **GOLD**. Sottotop, pilastri e cassetti in pelle **ZENITH 666**. Elemento angolare con vano a giorno ed elemento laterale con anta a battente in vetro curvato. Interno con illuminazione led e mensole in vetro trasparente.

L'ambiente è arricchito dalla poltrona **JACQUARD** in velluto **DENIM 123** ed il tavolino **DUNE** in finitura **BLACK OPACO** con piedini in metallo **GOLD** e top in laminam **PIETRA DI SAVOIA**. A completare la scena il divano **OLIVER**, il tavolino **SURF** ed il pouff **ERIK**.

The flexibility of the **SYSTEM 03** modular unit is highlighted by the presence of the corner glass module and a large central compartment of 180 cm for the TV. The structure is in **MATT EBONY** finish and details in **GOLD** metal. Undertop, pillars and drawers in **ZENITH 666** leather. Corner element with open compartment and side element with hinged door in curved glass. Interior with led lighting and transparent glass shelves.

The setting is enriched by the **JACQUARD** armchair in **DENIM 123** velvet and the **DUNE** coffee table in **MATT BLACK** finish with **GOLD** metal feet and top in **PIETRA DI SAVOIA** laminam. To complete the scene, the **OLIVER** sofa, the **SURF** coffee table and the **ERIK** pouffe.



DINING ROOM

DINING ROOM













L'ambiente dining presenta il **SYSTEM 04** con composizione lineare in finitura SICOMORO e dettagli in metallo finitura TITANIO. Sottotop e pilastri in pelle ZENITH 634. Elementi laterali con ante a battente in vetro curvato, all'interno dei vari elementi e mensole in vetro per riporre ceramiche ed oggetti in cristallo illuminati da led.

Il tavolo **TIGHT** con struttura in legno sagomato finitura SICOMORO arricchito dal piano in marmo GIOIA WHITE e le sedie **ALINA** con struttura in legno sagomato e rivestite in pelle ZENITH 660 e tessuto ZEUS 02 con trapuntatura e logo aziendale sono gli elementi centrali della scena, eleganti e comodi, pensati per i momenti conviviali.

A chiudere la composizione vi sono la credenza **JAGO** con struttura in legno laccato MOKA OPACO dettagli in metallo ROSE con e sottotop in pelle ZENITH 666 e la boiserie composta da pannelli in legno SICOMORO, profili in metallo finitura TITANIO, completata da inserti in pelle ZENITH 634 ed illuminazione led che elegantemente rifiniscono tutto l'ambiente.

The dining room features **SYSTEM 04** with linear composition in SICOMORO finish and details in TITANIUM finish metal. Undertop and pillars in ZENITH 634 leather. Side elements with hinged doors in curved glass, inside the various elements and glass shelves for storing ceramics and crystal objects illuminated by led.

The **TIGHT** table with shaped wooden structure SICOMORO finish enriched by the GIOIA WHITE marble top and the **ALINA** chairs with shaped wooden structure covered in ZENITH 660 leather and ZEUS 02 fabric with quilting and company logo are the central elements of the scene, elegant and comfortable, designed for convivial moments.

The composition is closed by the **JAGO** sideboard with MATT MOKA lacquered wood structure, ROSE metal details with and undertop in ZENITH 666 leather and the boiserie composed of matt SICOMORO wood panels, TITANIUM finish metal profiles, completed by ZENITH leather inserts 634 and led lighting that elegantly finish the whole environment.









I due gruppi che compongono il **SYSTEM 05** presentano struttura e schienali in legno laccato **SHADE OPACO** e dettagli in finitura **CHAMPAGNE**. Sottotop e pilastri rivestiti con inserti in pelle **ZENIT 663**. Ante laterali battenti in vetro curvato presentano al suo interno illuminazione led e mensole in vetro trasparente.

Un modulo si presenta con la parte superiore con sportelli a vetro e quella inferiore con sportelli laccati, mentre l'altro si presenta con ante centrali a giorno con spazi pensati per riporre oggetti e libri e cassetti rivestiti con inserti in pelle **ZENIT 663**.

Completano la proposta il tavolo **FRAC** con struttura in legno laccato **SHADE OPACO** con top in laminam **PIETRA DI SAVOIA** composto da tre parti con sottotop in legno, le sedie **KALLY** in legno di faggio con finitura laccata **SHADE OPACO** rivestite in tessuto **DENIM 35** ed il tappeto **ROUND** in aspetto velluto con ricamato il logo aziendale rendendo la scena confortevole ed accogliente.

The two groups that make up **SYSTEM 05** have structure and backs in **SHADE MATT** lacquered wood and details in **CHAMPAGNE** finish. Undertop and pillars covered with **ZENIT 663** leather inserts. Hinged side doors in curved glass have internal led lighting and transparent glass shelves.

One module has the upper part with glass doors and the lower one with lacquered doors, while the other has central open doors with spaces designed for storing objects and books and drawers lined with **ZENIT 663** leather inserts.

The proposal is completed by the **FRAC** table with structure in **MATT SHADE** lacquered wood with top in **PIETRA DI SAVOIA** laminam composed of three parts with wooden undertop, the **KALLY** chairs in beech wood with **SHADE MATT** lacquered finish covered in **DENIM 35** fabric and the **ROUND** carpet in velvet look with the company logo embroidered making the scene comfortable and welcoming.



Semplicità e linearità sono le caratteristiche che denotano il **SYSTEM 06** con struttura e schienali in OAK e dettagli in metallo ROSE. Sottotop, pilastri e cassetti arricchiti con inserti in pelle ZENITH 627. Le ante laterali battenti in vetro curvato presentano all'interno illuminazione led e mensole trasparenti.

Simplicity and linearity are the characteristics that denote the **SYSTEM 06** with structure and backs in OAK and details in ROSE metal. Undermount, pillars and drawers enriched with ZENITH 627 leather inserts. The hinged side doors in curved glass have led lighting and transparent shelves inside.





OFFICE

OFFICE









Lusso ed eleganza pensati per l'ufficio sono presentati qui e nelle prossime pagine. Le caratteristiche che accompagnano questa linea sono la funzionalità e la possibilità di offrire un arredo elegante senza compromettere il coworking.

Il **SYSTEM 07** ha struttura e schienali in OAK, dettagli in metallo CHAMPAGNE, sottotop e pilastri arricchiti con inserti in pelle ZENITH 627. La parte inferiore del sistema si presenta con composizione sia a cassetti rivestiti in pelle ZENITH 627 che ad ante in essenza. Le ante laterali battenti in vetro curvato presentano illuminazione led all'interno e mensole in vetro trasparente. La scrivania **TECH** con struttura, cassetti e base in legno sagomato OAK ha dettagli in metallo CHAMPAGNE, top e sottotop arricchiti in pelle ZENITH 627.

Corredate alla scrivania sono la poltrona girevole per ufficio **MYFAIR** con struttura in legno imbottito rivestito in pelle ZENITH 627 con base in metallo e la sedia per ufficio **ALBERT** con struttura in legno rivestita in pelle ZENITH 627 e base in metallo.

La boiserie composta da pannelli in legno OAK, profili in metallo CHAMPAGNE, arricchita da inserti in pelle ZENITH 627 completa con sobrietà lo spazio.

Luxury and elegance designed for the office are presented here and in the following pages. The features that accompany this line are functionality and the possibility of offering elegant furniture without compromising coworking.

**SYSTEM 07** has structure and backrests in OAK, details in CHAMPAGNE metal, undertop and pillars enriched with ZENITH 627 leather inserts. The lower part of the system has a composition of both drawers covered in ZENITH 627 leather and wood doors. The hinged side doors in curved glass have internal led lighting and transparent glass shelves. The **TECH** desk with structure, drawers and base in OAK shaped wood has details in CHAMPAGNE metal, top and undermount enriched in ZENITH 627 leather.

Accompanied by the desk are the **MYFAIR** swivel office armchair with a padded wooden structure covered in leather ZENITH 627 with metal base and the **ALBERT** office chair with wooden structure covered in ZENITH 627 leather and metal base.

The boiserie made up of OAK wood panels, champagne metal profiles, enriched with ZENITH 627 leather inserts, completes the space with sobriety.













Il **SYSTEM 08** si presenta con struttura e schienali e cassetti in OAK, dettagli in metallo CHAMPAGNE, sottotop e pilastri arricchiti con inserti in pelle ZENITH 627. Ante a giorno stile libreria con all'interno mensole in vetro trasparenti ed illuminazione led.

The **08 SYSTEM** has a structure and backrests and drawers in OAK, CHAMPAGNE metal details, undertop and pillars enriched with ZENITH 627 leather inserts. Bookcase-style open doors with transparent glass shelves inside and led lighting.







In questa pagina e nelle seguenti viene presentato il **SYSTEM 09** che, con la sua struttura in legno laccato CRETA OPACO, dona luminosità alla zona ufficio. Il sottotop, i pilastri ed i cassetti sono impreziositi da inserti in pelle ZENITH 666; i dettagli sono in metallo TITANIO, le ante laterali battenti in vetro curvato presentano all'interno illuminazione led e mensole in vetro trasparente. L'anta centrale a giorno è il luogo ideale dove riporre i fascicoli.

La scrivania **PIXEL** con struttura a cassetti e base sagomata in legno laccato CRETA OPACO raggiunge la sua eleganza con i dettagli in pelle ZENITH 666 del top; i dettagli in metallo sono in finitura TITANIO. È disponibile anche nella versione con doppia cassetiera.

La poltrona girevole per ufficio **MYFAIR** ha struttura in legno imbottita e rivestita in pelle ZENITH 666 e la base in metallo.

La sedia **CLIP** con struttura in legno sagomato rivestito in pelle ZENITH 666 è rifinita da particolari cuciture.

Il tavolo riunioni **BELMONT** offre la possibilità di essere personalizzato nelle dimensioni. Si presenta alle pagine 60, 61 e 63 con struttura ovale allungata in legno laccato CRETA OPACO sagomato, apportando eleganza e praticità ad un ambiente pensato per organizzare e gestire il lavoro. Le basi sagomate con struttura in legno ed il top sono rivestiti in pelle ZENITH 666; alle pagine 64-65, insieme alla sedia **CLIP**, si presenta invece in finitura EBONY OPACO e pelle ZENITH 627 con dettagli in finitura CHAMPAGNE.

On this page and in the following the **SYSTEM 09** is presented which, with its structure in MATT CRETA lacquered wood, gives brightness to the office area. The undermount, the pillars and the drawers are embellished with ZENITH 666 leather inserts; the details are in TITANIUM metal, the hinged side doors in curved glass have internal led lighting and transparent glass shelves. The central open door is the ideal place to store the files.

The **PIXEL** desk with drawer structure and shaped base in CRETA OPACO lacquered wood reaches its elegance with the ZENITH 666 leather details of the top; the metal details are in TITANIUM finish. It is also available in the version with double drawers.

The **MYFAIR** office swivel armchair has a wooden structure padded and upholstered in ZENITH 666 leather and a metal base.

The **CLIP** chair with shaped wooden structure covered in ZENITH 666 leather is finished with special stitching.

The **BELMONT** meeting table offers the possibility of being customized in size. It is presented on pages 60, 61 and 63 with an elongated oval structure in shaped MATT CRETA lacquered wood, bringing elegance and practicality to an environment designed to organize and manage work. The shaped bases with wooden structure and the top are covered in ZENITH 666 leather; on page 64-65, together with the **CLIP** chair, it is presented in a finish MATT EBONY and leather ZENITH 627 with CHAMPAGNE metal finishes.

























BEDROOM

BED  
ROOM













L'armadio contiene il nostro modo di presentarci agli altri e rispecchia il nostro modo di vivere, per questo la progettazione ha dato particolare importanza al **SYSTEM 10** pensato, nella versione classica o come cabina armadio, per tenere in ordine tutti gli oggetti facenti parte del nostro quotidiano.

La struttura lineare del **SYSTEM 10** è in legno OAK con sottotop e pilastri arricchiti da inserti in pelle ZENITH 627 e dettagli in metallo ROSE. Le ante battenti con vetri trasparenti contribuiscono ad alleggerire il peso dell'armadio rendendolo un arredo pratico ed estetico. Al loro interno ripiani in legno OAK e barre appendiabiti in metallo. I cassetti con finitura in pelle ZENITH 627 e l'organizer per le camicie in legno OAK.

Non esiste cabina senza pouffe comodo dove sedersi per indossare i vestiti e sistemare gli accessori e tappeto per poter stare a piedi nudi nell'attesa di scegliere l'indumento più adatto per uscire. In particolare il pouff **ERIK** ed i tappeti **ROYAL** e **ROUND** in aspetto velluto.

The wardrobe contains the way we present ourselves to others and reflects our way of life, which is why the design has given particular importance to the **SYSTEM 10**, designed, in the classic version or as a walk-in closet, to keep all the objects belonging to the our daily.

The linear structure of **SYSTEM 10** is in OAK wood with undertop and pillars enriched with ZENITH 627 leather inserts and ROSE metal details. The hinged doors with transparent glass help to lighten the weight of the wardrobe making it a practical and aesthetic piece of furniture. Inside they are wooden shelves OAK and metal clothes hanger bars. The drawers with ZENITH 627 leather finish and the organizer for shirts in OAK wood.

There is no cabin without a comfortable pouffe where you can sit to put on your clothes and arrange the accessories and carpet to be able to stay barefoot while waiting to choose the most suitable garment to go out. In particular, the **ERIK** pouffe and the **ROYAL** and **ROUND** rugs in velvet look.









Ampia zona notte dove la sinuosità del **SYSTEM 11** rende accogliente tutto l'ambiente, con la sua struttura in legno laccato **GLACIAL OPACO**. Ante laterali curve laccate e ante centrali in vetro trasparente; sottotop, pilastri e cassetti interni con dettagli in pelle **ZENITH 663**. Schienali, ripiani ed organizer per camicie in legno **WALNUT**, dettagli in metallo **TITANIO** ed illuminazione interna a led. Completano la scena il pouff **ERIK** ed il tappeto **ROYAL** in aspetto velluto.

Large sleeping area where the sinuosity of the **SYSTEM 11** makes the whole environment welcoming, with its **GLACIAL MATT** lacquered wood structure. Lacquered curved side doors and central doors in transparent glass; undertop, pillars and internal drawers with **ZENITH 663** leather details. Backrests, shelves and organizer for shirts in **WALNUT** wood, details in **TITANIUM** metal and internal led lighting. The **ERIK** pouffe and the **ROYAL** carpet in velvet look complete the scene.







Il SYSTEM 12 presenta una struttura in legno laccato CRETA OPACO, con ante laterali laccate ed ante centrali in vetro trasparente; sottotop, pilastri e cassetti interni con dettagli in pelle ZENITH 666. Schienali e ripiani in legno WALNUT. Al centro cassetti e ripiani con struttura in legno WALNUT. Illuminazione interna a led.

SYSTEM 12 has a structure in matt CRETA lacquered wood, with lacquered side doors and central doors in transparent glass; undermount, pillars and internal drawers with details in ZENITH 666 leather. Backs and shelves in WALNUT wood. In the center, drawers and shelves with structure in WALNUT wood. Internal led lighting.









Il **SYSTEM 13** è pensato e progettato per adattarsi non solo ad un uso residenziale, ma anche a negozi e boutique, studiato per vedere al suo interno, nel dettaglio, ciò che fa parte di noi.

La struttura in legno OAK ha elementi angolari curvati con ante in vetro trasparente. Le ante, tutte in vetro, presentano al suo interno ripiani, struttura dei cassetti e schienali in legno OAK. Il sottotop, i cassetti ed i pilastri hanno dettagli in pelle ZENITH 627 che gli conferiscono eleganza. Dettagli sono in metallo ROSE. Illuminazione led interna.

L'isola centrale **BLOOM** con struttura in legno OAK, top ovale in vetro trasparente, cassetti con frontale in vetro in cui è possibile riporre cravatte, calzette e foulard, dettagli in pelle ZENITH 627 e particolari in metallo ROSE sono l'esempio perfetto di un design che coniuga funzione ed estetica in modo semplice ed elegante.

**SYSTEM 13** is conceived and designed to adapt not only to residential use, but also to shops and boutiques, designed to see inside, in detail, what is part of us.

The OAK wooden structure has curved corner elements with transparent glass doors. The doors, all in glass, have inside shelves, drawer structures and backs in OAK wood. The undermount, the drawers and the pillars have details in ZENITH 627 leather that give it elegance. Internal led lighting.

The central island **BLOOM** with structure in OAK wood, oval top in transparent glass, drawers with glass front in which it is possible to store ties, socks and scarves, details in ZENITH 627 leather and ROSE metal details are the perfect example of a design that combines function and aesthetics in a simple and elegant way.

















Il **SYSTEM 14** ha una struttura in legno laccato **SHADE OPACO**, ante in legno e vetro trasparente; sottotop, pilastri e cassetti interni con dettagli in pelle **ZENIT 663**, schienali e ripiani con struttura in legno **WALNUT**, dettagli in metallo **ROSE**, illuminazione led. Di fronte il pouff **ERIK** con basamento in legno rivestito in metallo sono imbottiti e rivestiti in tessuto, il tavolino **TRENDY** con top in laminam **PIETRA DI SAVOIA**, sottotop e gambe in legno laccato **BLACK OPACO** e dettagli in metallo **ROSE** ed il tappeto **SOFT**.

**SYSTEM 14** has a **SHADE OPACO** lacquered wood structure, wooden doors and transparent glass; undertop, pillars and internal drawers with **ZENIT 663** leather details, backrests and shelves with structure in **WALNUT** wood, **ROSE** metal details, led lighting. Opposite the **ERIK** pouffe with metal-covered wooden base are padded and upholstered in fabric, the **TRENDY** coffee table with **PIETRA DI SAVOIA** laminam top, undertop and legs in **BLACK MATT** lacquered wood and **ROSE** metal details and the **SOFT** carpet.













La collezione si estende alle camere da letto dove l'estetica si coniuga al relax ed in cui la qualità e la funzionalità trovano il loro perfetto equilibrio. Un ambiente elegante ed ordinato in cui la mente ed il corpo riposano e riacquistano energia.

Il letto **LOVE**, particolarmente avvolgente, ha la testata ed il giroletto in legno sagomato completamente imbottiti e rivestiti in tessuto **BELLINI 113**, con dettaglio in metallo finitura titanio. Disponibile con rete fissa o ribaltabile con base contenitore.

I comodini **PAUL** con struttura e piano in legno **OAK**, dettagli in metallo **ROSE** e pelle **ZENITH 627** si abbinano alla toilette **PATTY**, concepita con lo stesso design e le stesse finiture, arricchita da un piano con specchio apribile a ribalta che chiude un vano porta oggetti. Il pouff **MORGAN** con struttura in legno, imbottito e rivestito in pelle **ZENITH 627** e dettagli in metallo **ROSE**, si abbinano alla toilette completando l'angolo dedicato alla cura del corpo.

Il **SYSTEM 15** correda l'ambiente con struttura in legno laccato **MOKA OPACO**, ante laterali in legno curvato, ante centrali in legno e vetro trasparente; sottotop, pilastri e cassetti interni con dettagli in pelle **ZENITH 627**, schienali e ripiani con struttura in legno **WALNUT**, dettagli in metallo **TITANIO**, illuminazione led. È disponibile anche su misura.

Nell'altra stanza, la poltrona **CHIFFON** con telaio in metallo, imbottita e rivestita in **TESSUTO ZEUS 04** ed il tavolino **ELAN** con struttura in legno, dettagli in metallo **TITANIO** e top in laminam **PIETRA DI SAVOIA**, completano l'ambiente con eleganza e raffinatezza.

The collection extends to bedrooms where aesthetics are combined with relaxation and where quality and functionality find their perfect balance. An elegant and tidy environment in which the mind and body rest and regain energy.

The **LOVE** bed, particularly enveloping, has the headboard and the bed frame in shaped wood completely padded and covered in **BELLINI 113** fabric, with titanium metal detail. Available with fixed or folding base with storage base.

**PAUL** bedside tables with structure and top in **OAK** wood, details in pink metal and **ZENITH 627** leather are combined with the **PATTY** dressing table, conceived with the same design and the same finishes, enriched by a top with a flip-open mirror that closes a storage compartment.

The **MORGAN** pouffe with wooden frame, padded and upholstered in **ZENITH 627** leather and **ROSE** metal details, matches the toilet by completing the corner dedicated to body care.

The **SYSTEM 15** furnishes the environment with a **MOKA MATT** lacquered wood structure, side doors in curved wood, central doors in wood and transparent glass; undertop, pillars and internal drawers with **ZENITH 627** leather details, backrests and shelves with **WALNUT** wooden structure, details in **TITANIUM** metal, led lighting. It is also available made to measure.

In the other room, the **CHIFFON** armchair with metal frame, padded and upholstered in **ZEUS 04 FABRIC** and the **ELAN** coffee table with wooden structure, **TITANIUM** metal details and **PIETRA DI SAVOIA** laminam top, complete the setting with elegance and refinement.































La combinazione di legno e pelle ha dato vita a questa idea di stile. Il letto **MASTER** ha una struttura in legno OAK su cui risalta il giroletto ed i cuscini della testata in tessuto ZEUS 05 che poggiano su una cornice in pelle COCCODRILLO.

Il comò **GLOVE** ed i comodini **TAYLOR** presentano una struttura in legno OAK, con top e particolari dettagli in pelle COCCODRILLO che denotano la collezione dal design e dal gusto raffinato. Disponibili anche nella versione in legno laccato CRETA OPACO.

Il **SYSTEM 16**, incassato nella parete, presenta una struttura in legno OAK con fianchi dritti ed ante in vetro trasparente. Sottotop, pilastri e cassetti interni con particolari dettagli in pelle COCCODRILLO, schienali e ripiani con struttura in legno OAK, dettagli in metallo ROSE ed illuminazione led.

The combination of wood and leather gave birth to this idea of style. The **MASTER** bed has an OAK wood structure on which the bed frame and the headboard cushions in ZEUS 06 fabric stand out and rest on a CROCODILE leather frame.

The **GLOVE** chest of drawers and the **TAYLOR** bedside tables have an OAK wood structure, with top and particular details in CROCODILE leather that denote the collection with a refined design and taste. Also available in the MATT CRETA lacquered wood version.

**SYSTEM 16**, built into the wall, has a OAK wood structure with straight sides and transparent glass doors. Undertop, pillars and internal drawers with particular details in CROCODILE leather, backrests and shelves with OAK wood structure, ROSE metal details and led lighting.













I ragazzi hanno l'esigenza di spazi organizzati e personali dove iniziare sempre nuove attività. In questi spazi ogni elemento si trasforma per accompagnarli nella crescita.

Il sistema cameretta pensato da Antonelli Atelier risolve queste esigenze funzionali creando un ambiente dal design elegante, composto dall'armadio **HONEY**, il comodino **WISH** e il comò **TOUCH** con struttura in legno laccato **CRETA OPACO**, lavorazione cannettè sulle ante in legno laccato **GLACIAL OPACO** e dettagli in metallo **CHAMPAGNE**. Il letto **PLUME** con struttura in legno è imbottito e rivestito in velluto **DENIM 04**.

Completano la zona della cameretta dedicata allo studio la scrivania **SCREEN** con struttura in legno laccato **CRETA OPACO**, lavorazione cannettè sulle ante in legno laccato **GLACIAL OPACO** e dettagli in metallo **CHAMPAGNE** e la sedia girevole **ALBERT** in velluto **DENIM 04** e con base in metallo. Il tappeto **SOFT** accoglie con eleganza tutti gli elementi.

Young people need organized and personal spaces where they can always start new activities. In these spaces each element is transformed to accompany them in their growth.

The bedroom system designed by Antonelli Atelier solves these functional needs by creating an environment with an elegant design, consisting of the **HONEY** wardrobe, the **WISH** bedside table and the **TOUCH** chest of drawers with structure in **MATT CRETA** lacquered wood, cannettè processing on the doors in **GLACIAL MATT** lacquered wood and details in **CHAMPAGNE** metal. The **PLUME** bed with wooden frame is padded and covered in **DENIM 04** velvet.

The area of the small bedroom dedicated to the study is completed by the **SCREEN** desk with structure in **MATT CRETA** lacquered wood, cannettè processing on the **GLACIAL MATT** lacquered wood doors and **CHAMPAGNE** metal details and the **ALBERT** swivel chair in **DENIM 04** velvet and with metal base. The **SOFT** carpet elegantly welcomes all elements.



TECHNICAL SECTION

# SENTINEL TECHNICAL SECTION



# SYSTEMS

## PARETI COMPONENTI | MODULAR WALLS

**STRUTTURA** Legno impiallacciato o laccato con fianchi laterali curvati o dritti. Inserti in pelle o tessuto. Dettagli in metallo

**TOP** Legno laccato con dettagli in metallo

**CASSETTI** Legno. Frontali in essenza o laccati con possibilità di rivestimento in pelle o tessuto. Interno legno rivestito in microfibra e apertura con sistema push-pull

**MENSOLE** Vetro spessore 6/10 mm oppure in legno laccato o impiallacciato spessore 25/35 mm

**ANTE** Battente in vetro trasparente curvato

**ILLUMINAZIONE** Inserti in led

**STRUCTURE** Veneered or lacquered wood with curved or straight sides. Inserts in leather or fabric. Metal details

**TOP** Lacquered wood with metal details

**DRAWERS** Wood. Fronts in wood or lacquered with the possibility of covering in leather or fabric. Interior wood covered in microfiber and opening with push-pull system

**SHELVES** 6/10 mm thick glass or 25/35 mm thick lacquered or veneered wood

**DOORS** Hinged door in curved transparent glass

**LIGHTING** Led inserts

## BOISERIE | BOISERIE

**STRUTTURA** Legno impiallacciato o laccato. Inserti in pelle o tessuto. Dettagli in metallo

**ILLUMINAZIONE** Inserti in led

**STRUCTURE** Veneered or lacquered wood. Inserts in leather or fabric. Metal details

**LIGHTING** Led inserts

1A



1B



### SYSTEM 01

Struttura Structure  
OAK

Profondità Depth  
46 cm

#### SYSTEM 01 A

Moduli Modules  
SV004  
S009  
SV005  
SF (x2)

#### SYSTEM 01 B

Moduli Modules  
SB002-SX  
SB002-CX (x3)  
SB002-DX  
SB/P (x2)  
SB (x4)

1A

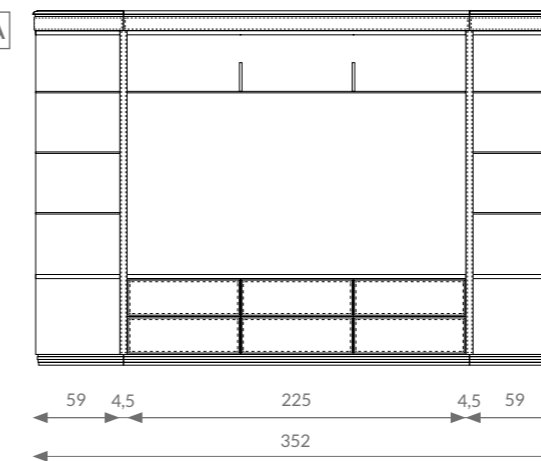

1B

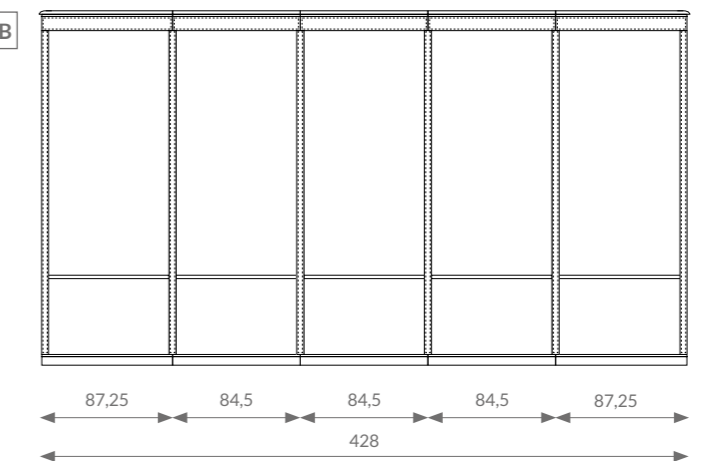

1A





### SYSTEM 02

Struttura Structure  
 AVORIO | OPACO MATT

Profondità Depth  
 46 cm

Moduli Modules  
 SV004  
 S007  
 S001  
 SV005  
 SF (x3)

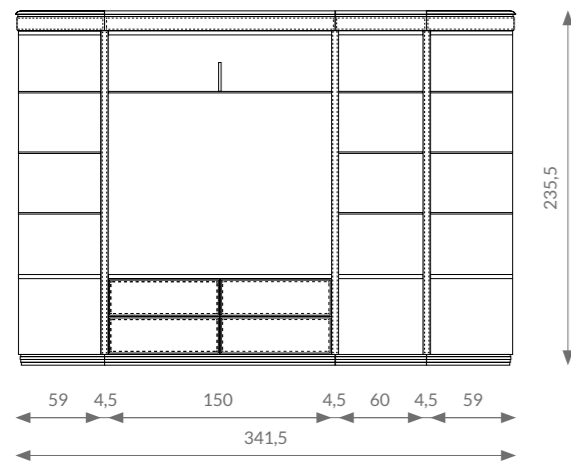

3B



### SYSTEM 03

Struttura Structure  
 EBONY

Profondità Depth  
 46 cm

SYSTEM 03 A  
 Moduli Modules  
 SV001  
 S001  
 S008  
 S001  
 S003  
 SV005  
 SF (x6)

SYSTEM 03 B  
 Moduli Modules  
 SV004  
 SV006  
 SF (x2)

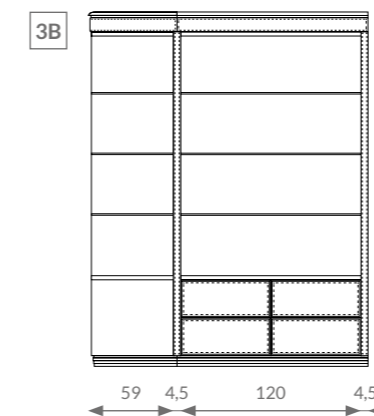
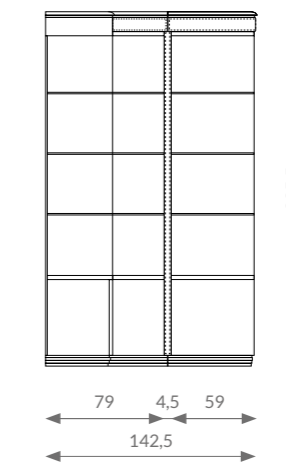
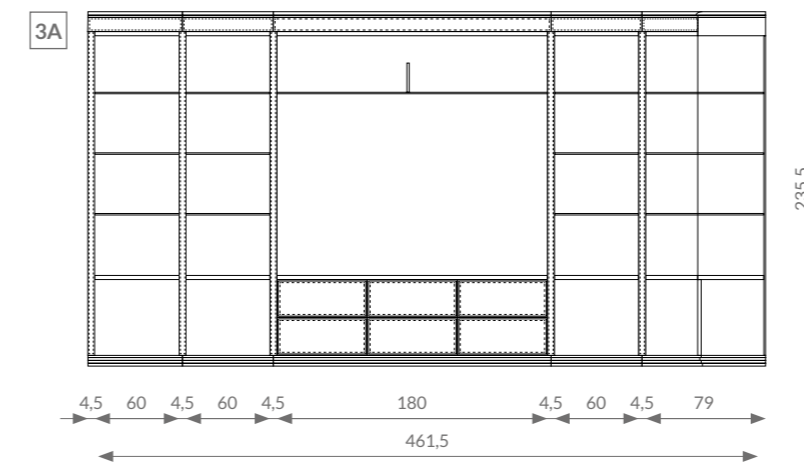



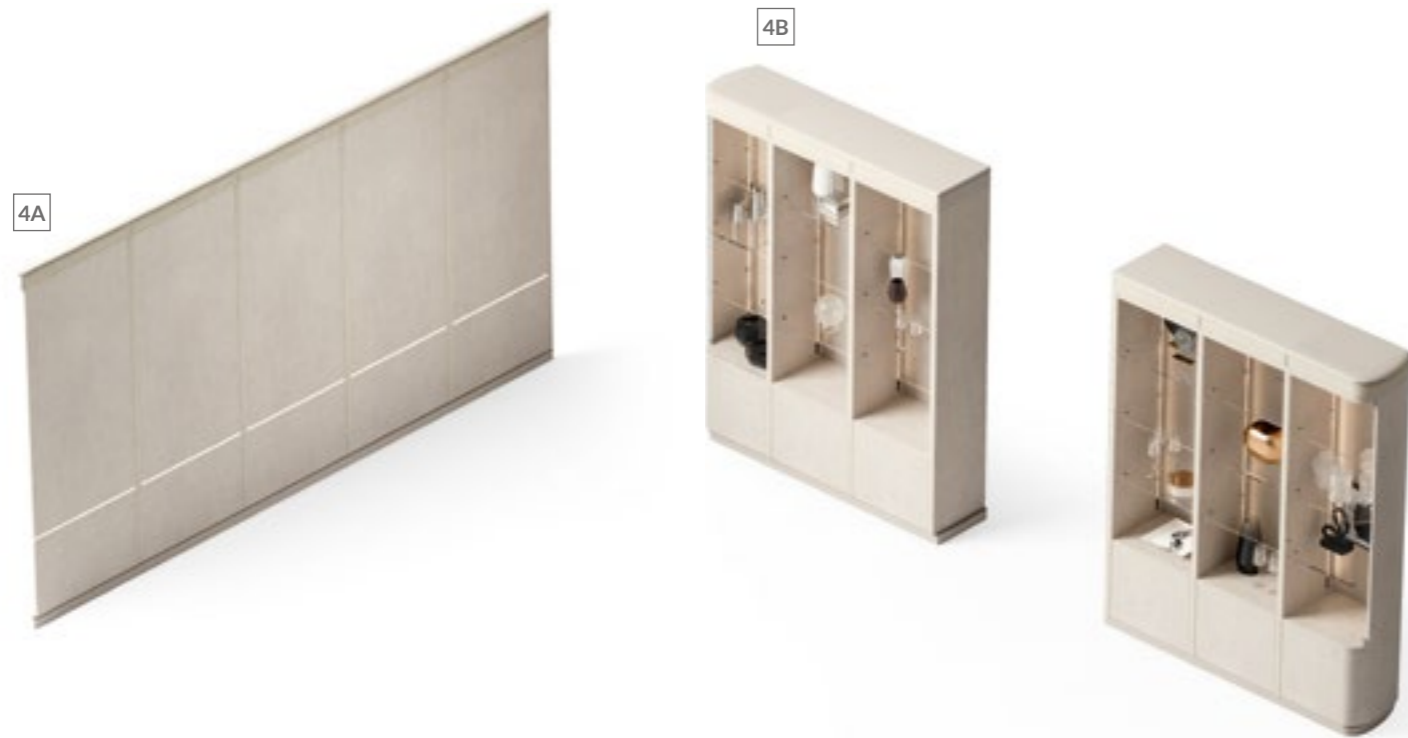

### SYSTEM 04

Struttura Structure  
SICOMORO

Profondità Depth  
46 cm

#### SYSTEM 04 A

Moduli Modules

SB002-SX  
SB002-CX (x3)  
SB002-DX  
SB/P (x2)  
SB (x4)

#### SYSTEM 04 B

Moduli Modules

SV004  
S001 (x2)  
SF (x3)

S001 (x2)  
SV005  
SF (x3)



### SYSTEM 05

Struttura Structure  
SHADE | OPACO MATT

Profondità Depth  
46 cm

#### SYSTEM 05 A

Moduli Modules

SV004  
SV010 (x2)  
SV005  
SF (x3)

#### SYSTEM 05 B

Moduli Modules

SV004  
S002 (x3)  
SV005  
SF (x4)

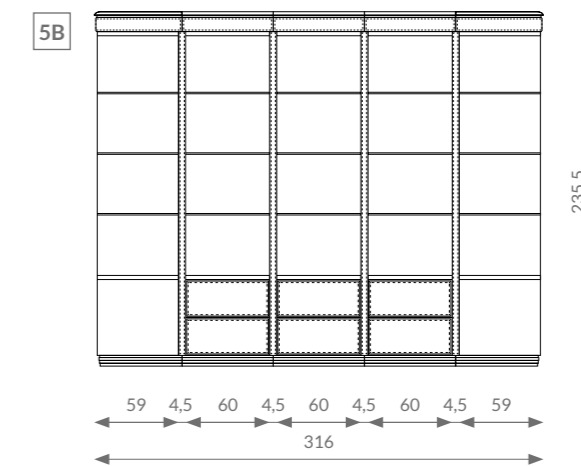
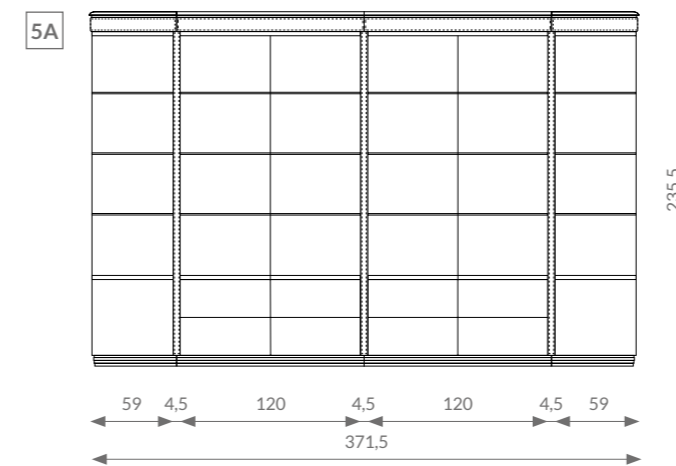
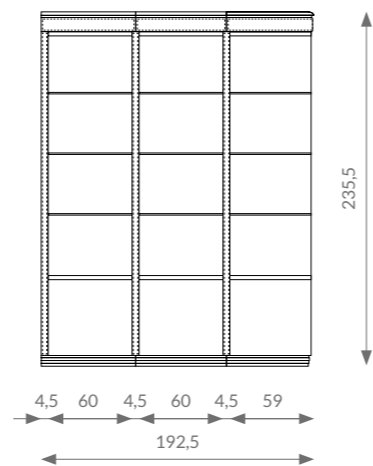
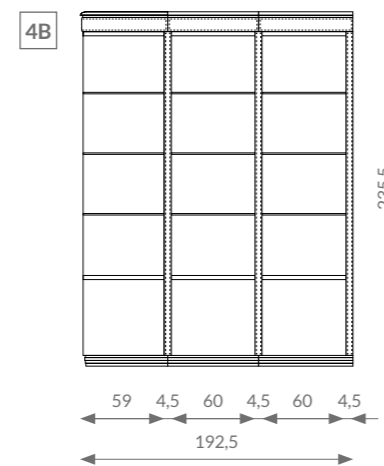
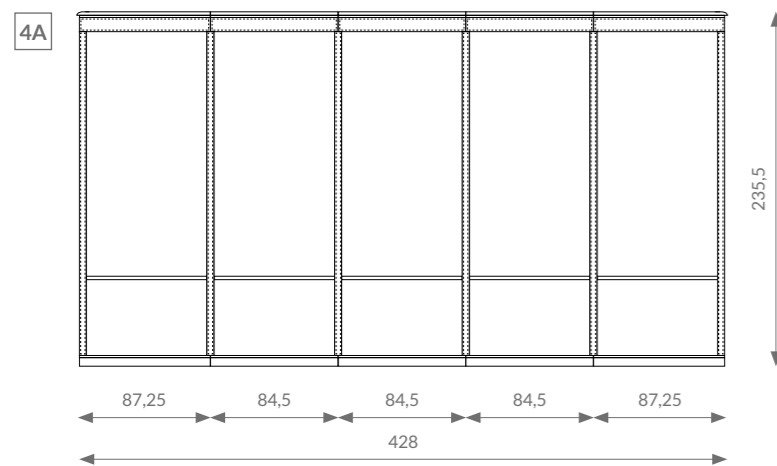





### SYSTEM 06

Struttura Structure  
OAK

Profondità Depth  
46 cm

Moduli Modules  
SV004  
SV001  
SV006  
SV005  
SF (x3)

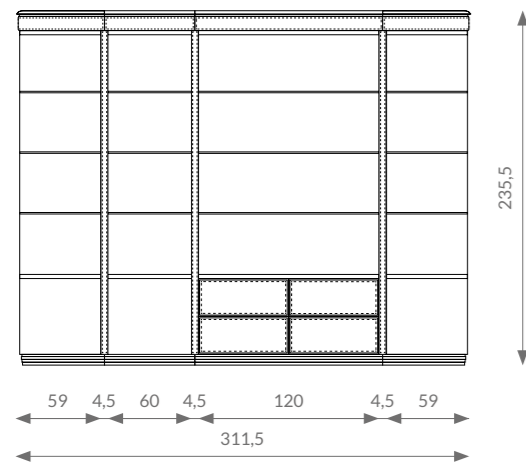

### SYSTEM 07

Struttura Structure  
OAK

Profondità Depth  
46 cm

#### SYSTEM 07 A

Moduli Modules  
SV004  
SV006  
SV005  
SF (x2)

SB001-SX  
SB001-CX  
SB001-DX  
SB/P (x2)  
SB (x1)

#### SYSTEM 07 B

Moduli Modules  
SV004  
SV010  
SV001  
SV006  
S003  
SV006  
SV001  
SV010  
SV005  
SF (x8)

SB001-CX  
SB001-DX  
SB/P (x1)  
SB (x1)

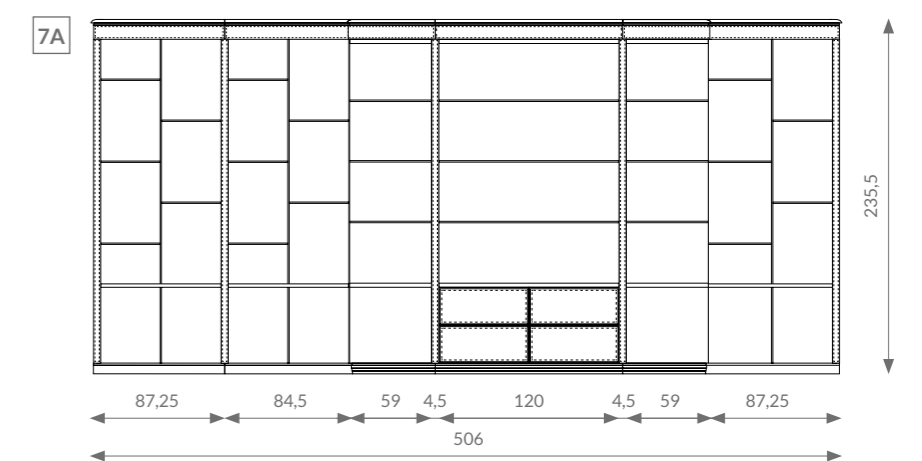
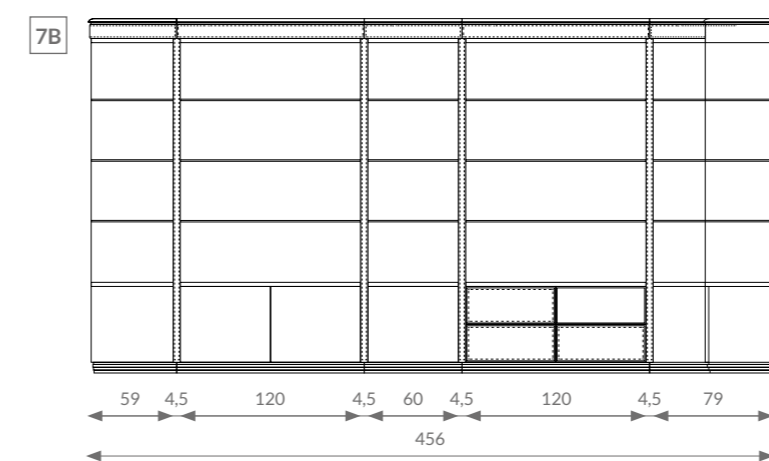
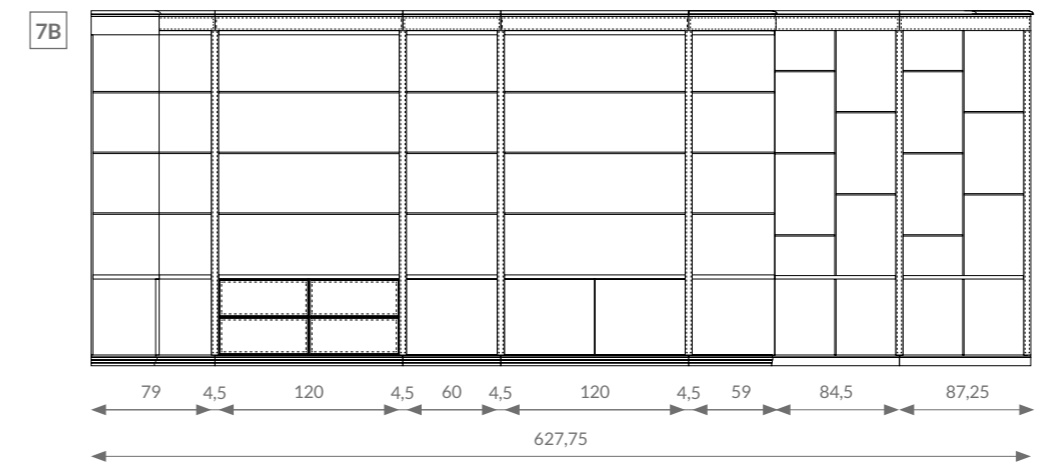





### SYSTEM 08

Struttura Structure  
OAK

Profondità Depth  
46 cm

Moduli Modules  
S002 (x4)  
SF (x5)

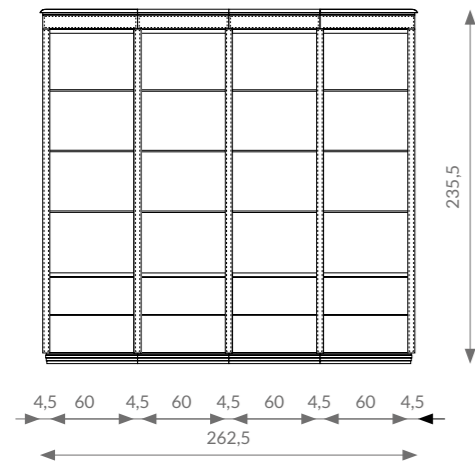

### SYSTEM 09

Struttura Structure  
CRETA | OPACO MATT

Profondità Depth  
46 cm

Moduli Modules  
SB001-SX  
SB001-CX  
SB/P (x1)  
SB (x1)  
SV004  
SV006  
S001  
SV006  
S003  
SV005  
SF (x5)

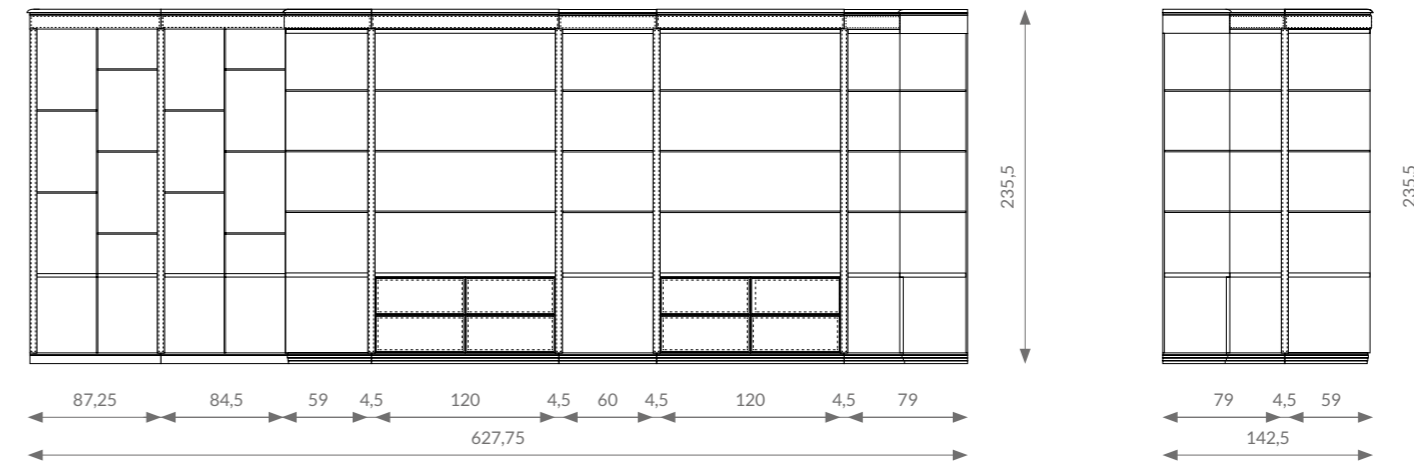





**SYSTEM 10**

Struttura Structure  
OAK

Profondità Depth  
60 cm

**SYSTEM 10 A**

Moduli Modules

SNV101  
SNV135  
SNV111  
SNV130  
SNV132 (x2)  
SNV130  
SNF (x8)

**SYSTEM 10 B**

Moduli Modules

SNL110  
SNL109  
SNL130  
SNL131  
SNF (x3)



**SYSTEM 11**

Struttura Structure  
GLACIAL | OPACO MATT

Profondità Depth  
60 cm

**SYSTEM 11 A**

Moduli Modules

SNL109  
SNV130  
SNL110  
SNF (x2)

SNL109  
SNV130  
SNL110  
SNF (x2)

**SYSTEM 11 B**

Moduli Modules

SNL109  
SNV135  
SNV111  
SNV134  
SNV130  
SNL110  
SNF (x5)

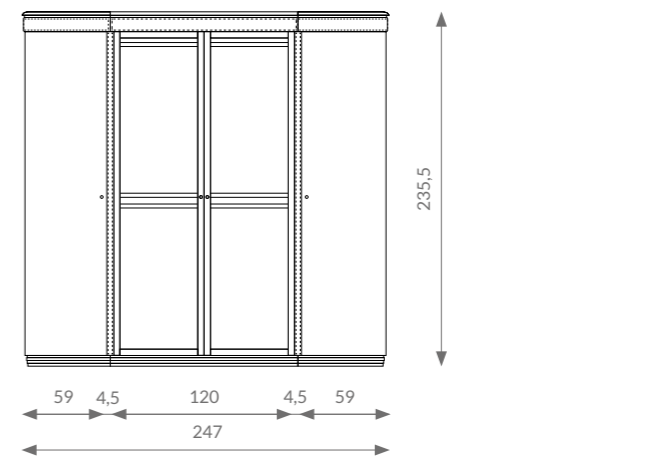
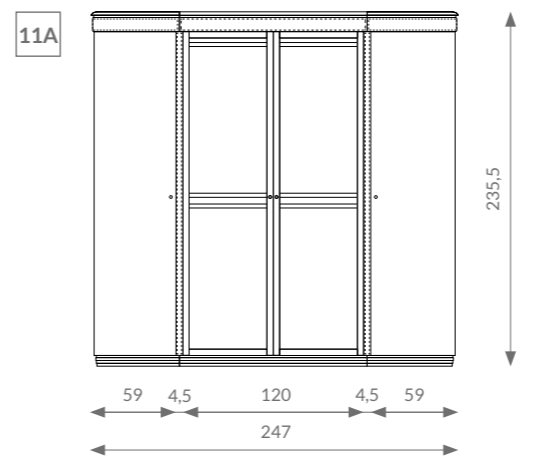
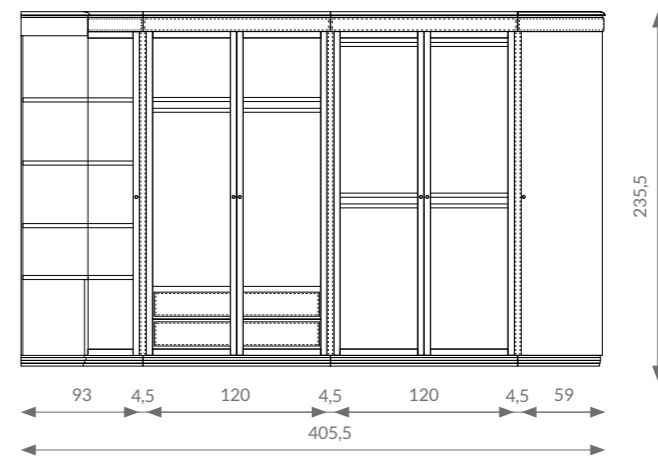
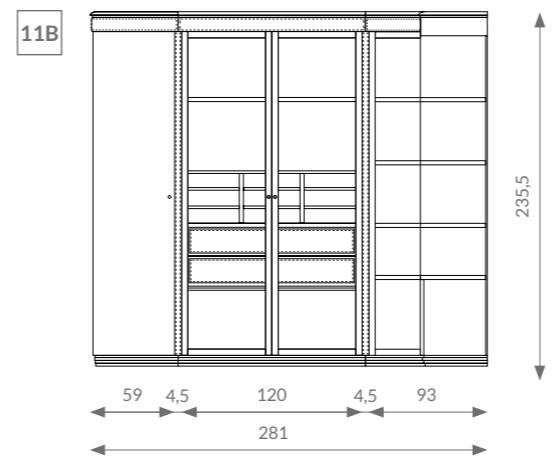
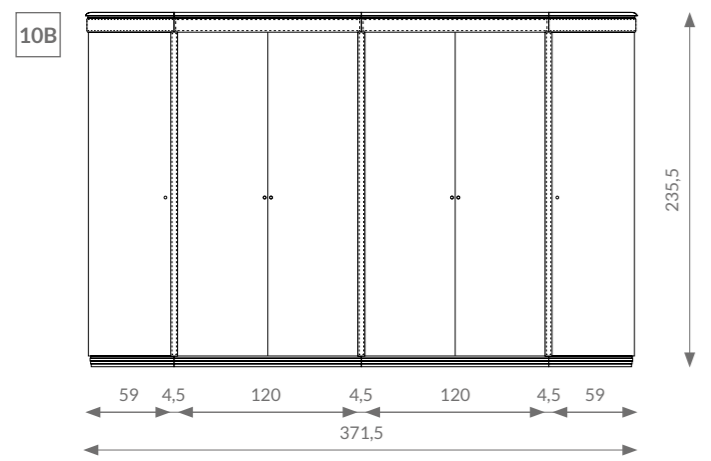
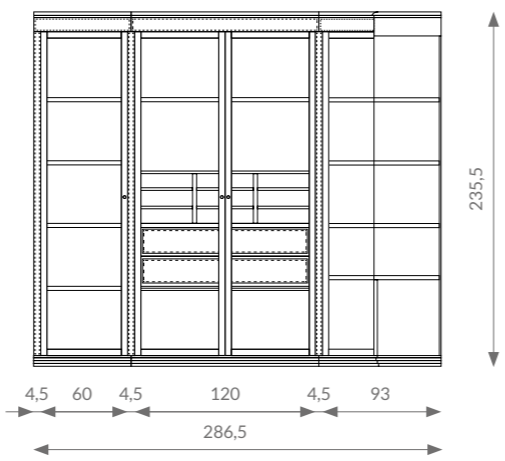
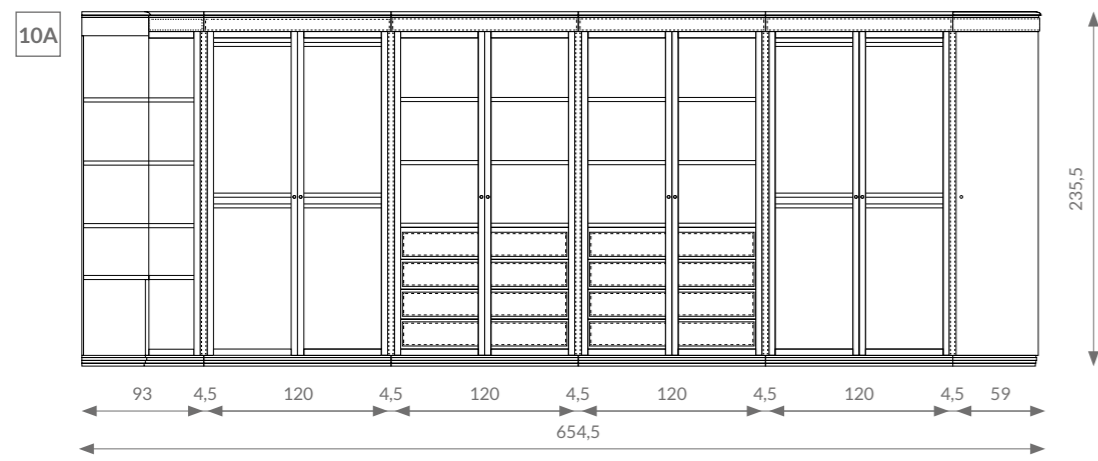





### SYSTEM 12

Struttura Structure  
CRETA | OPACO MATT

Profondità Depth  
60 cm

Moduli Modules

SNL109  
SNV130  
SNV102  
SNV130  
SNL110  
SNF (x4)

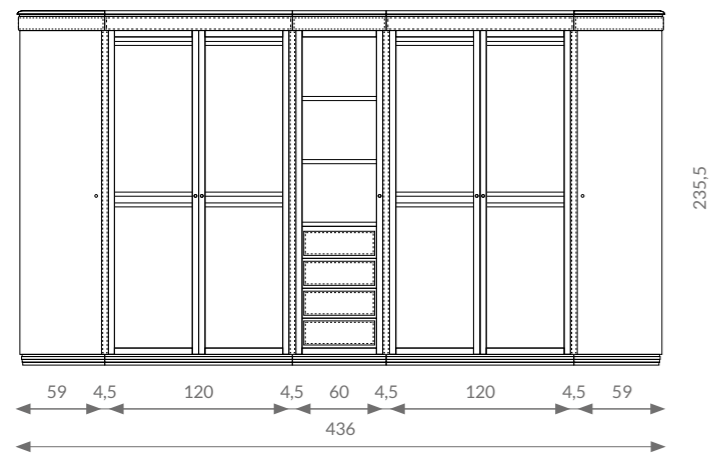

### SYSTEM 13

Struttura Structure  
OAK

Profondità Depth  
60 cm

Moduli speculari Mirror modules

SNV138  
SNV111 (x2)  
SNV131 (x2)  
SNV130  
SNV100  
SNF (x8)







**SYSTEM 14**  
 Struttura Structure  
 SHADE | OPACO MATT  
 Profondità Depth  
 60 cm  
 Moduli Modules  
 SNV130  
 SNV132  
 SNV130  
 SNF (x4)

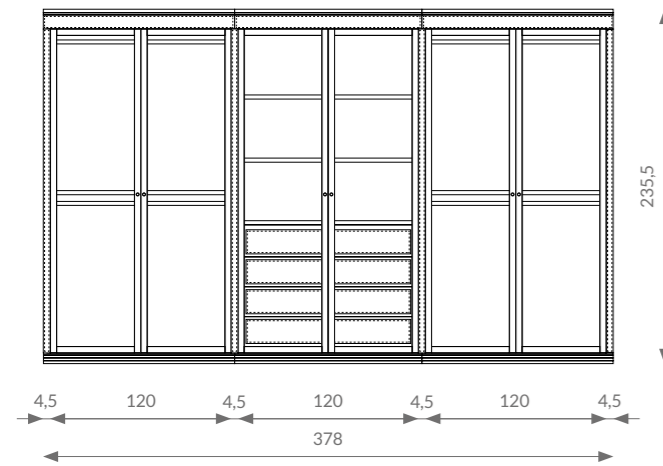

**SYSTEM 15**  
 Struttura Structure  
 MOKA | OPACO MATT  
 Profondità Depth  
 60 cm  
 Moduli Modules  
 SNL109  
 SNV134 (x2)  
 SNL110  
 SNF (x3)

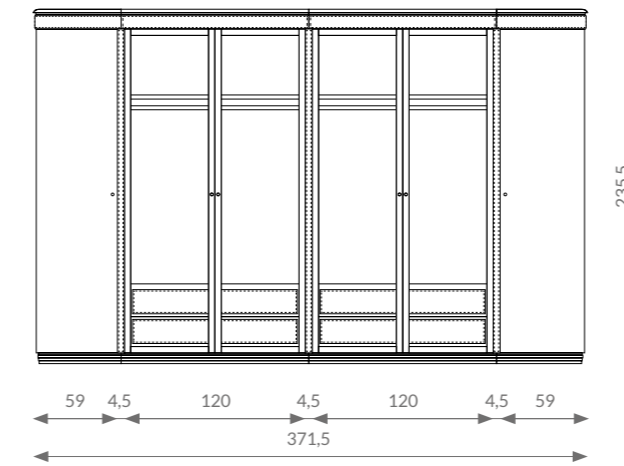





**SYSTEM 16**  
 Struttura Structure  
 OAK  
 Profondità Depth  
 60 cm  
 Moduli Modules  
 SNV132  
 SNV130  
 SNF (x3)

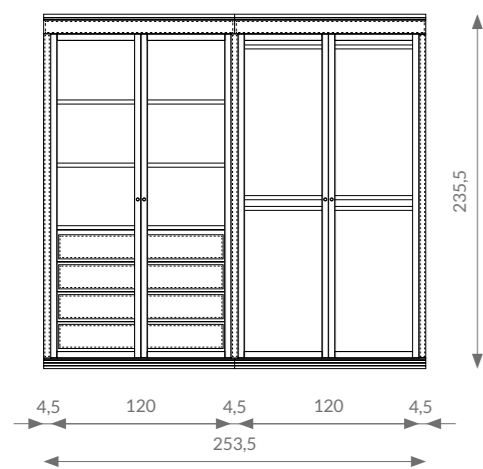

**ELEMENTI GIORNO | DAY ELEMENTS**  
 PROFONDITÀ DEPTH 46 CM | ALTEZZA HEIGHT 235 CM

**ELEMENTI CON CASSETTI INFERIORI | ELEMENTS WITH LOWER DRAWERS**

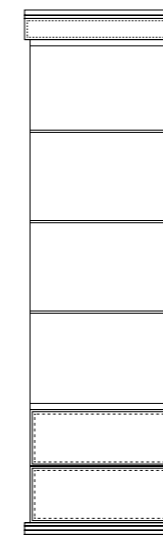

**S002 senza anta**  
**SV002 anta vetro**  
 CM 60 X 46 X 235,5 H

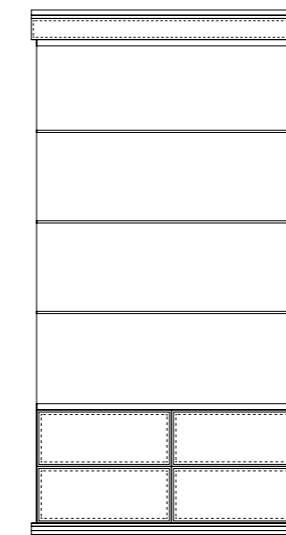

**S006 senza anta**  
**SV006 anta vetro**  
 CM 120 X 46 X 235,5 H

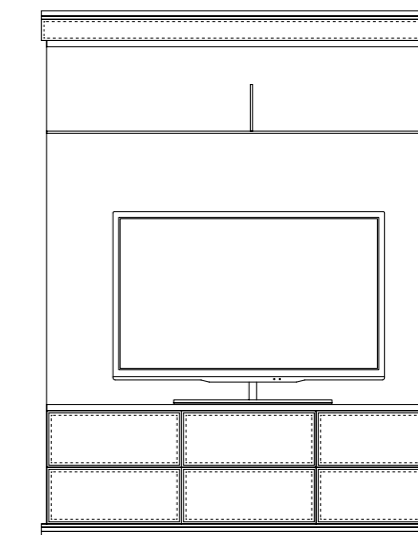

**S008 senza anta**  
 CM 180 X 46 X 235,5 H

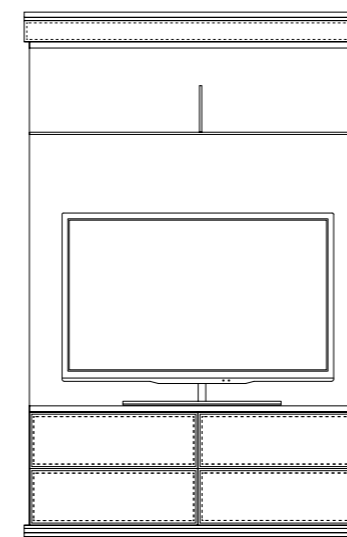

**S007 senza anta**  
 CM 150 X 46 X 235,5 H

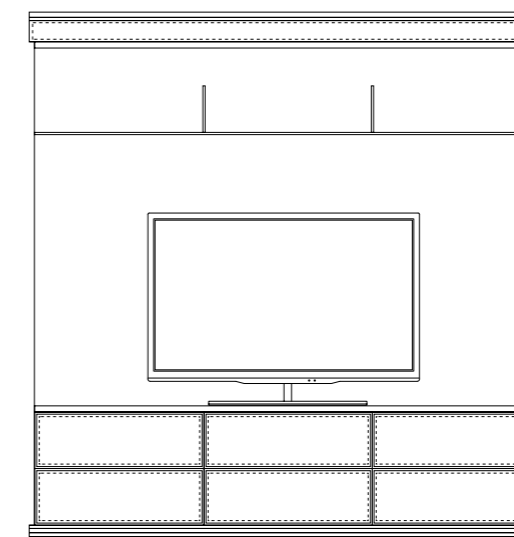

**S009 senza anta**  
 CM 225 X 46 X 235,5 H

**I moduli S001, S002, S006, S007, S008, S009 aumentano la misura del top di 2 cm per lato quando sono terminali non incassati**  
 The modules S001, S002, S006, S007, S008, S009 that increase the size of the top by 2 cm per side when they are not recessed terminals



## ELEMENTI GIORNO | DAY ELEMENTS

PROFONDITÀ DEPTH 46 CM | ALTEZZA HEIGHT 235 CM

### ELEMENTI CON SPORTELLI INFERIORI | ELEMENTS WITH LOWER DOORS

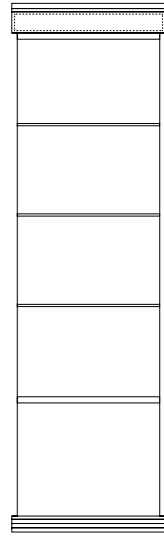

**S001 senza anta**  
**SV001 anta vetro**  
CM 60 X 46 X 235,5 H

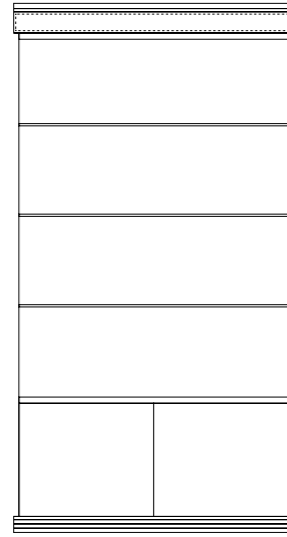

**S010 senza anta**  
**SV010 anta vetro**  
CM 120 X 46 X 235,5 H

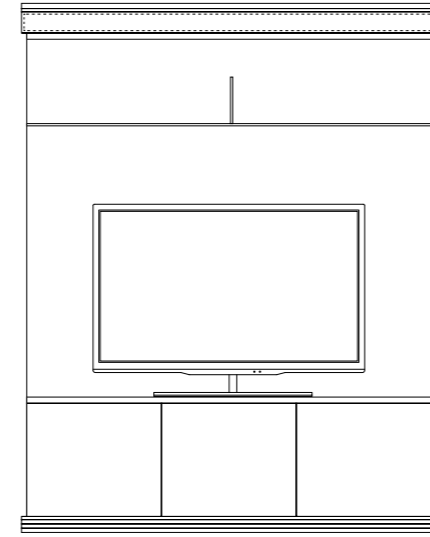

**S011 senza anta**  
CM 180 X 46 X 235,5 H

### ELEMENTO ANGOLARE | CORNER ELEMENT

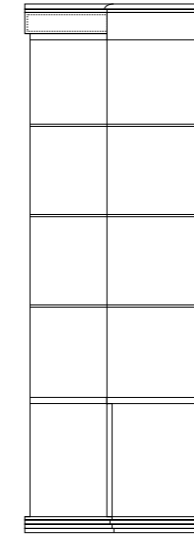

**S003 senza anta**  
**SV003 anta vetro**  
CM 79 X 79 X 235,5 H

### ELEMENTO PER CONNESSIONE | ELEMENT FOR CONNECTION



**SF**  
CM 4,5 X 46 X 215 H

### ELEMENTI TERMINALI CURVI | TERMINAL CURVED ELEMENTS

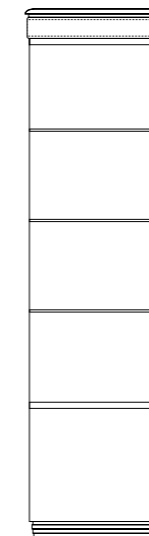

**S004 SX senza anta**  
**SV004 SX anta vetro**  
CM 59 X 46 X 235,5 H

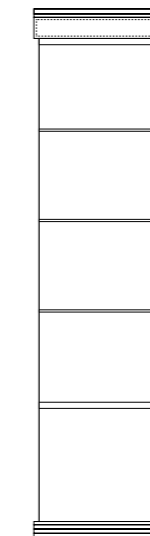

**S005 DX senza anta**  
**SV005 DX anta vetro**  
CM 59 X 46 X 235,5 H



**ELEMENTI NOTTE 60 | NIGHT ELEMENTS 60**  
 PROFONDITÀ DEPTH 60 CM | ALTEZZA HEIGHT 235 CM

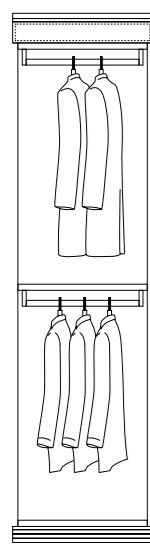

**SN100 senza anta**  
**SNV100 anta vetro**  
**SNL100 anta legno**  
 CM 60 X 60 X 235,5 H

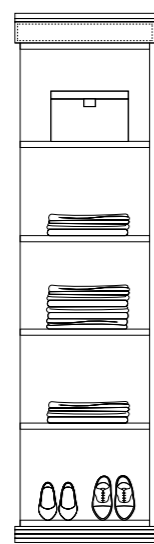

**SN101 senza anta**  
**SNV101 anta vetro**  
**SNL101 anta legno**  
 CM 60 X 60 X 235,5 H

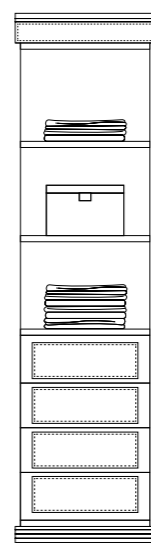

**SN102 senza anta**  
**SNV102 anta vetro**  
**SNL102 anta legno**  
 CM 60 X 60 X 235,5 H

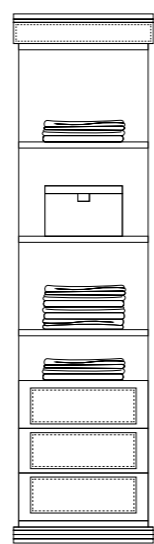

**SN103 senza anta**  
**SNV103 anta vetro**  
**SNL103 anta legno**  
 CM 60 X 60 X 235,5 H

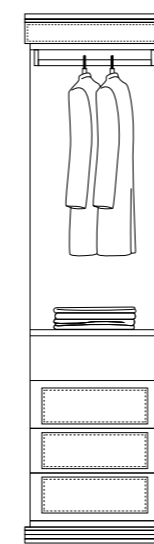

**SN108 senza anta**  
**SNV108 anta vetro**  
**SNL108 anta legno**  
 CM 60 X 60 X 235,5 H

**ELEMENTO PER CONNESSIONE | ELEMENT FOR CONNECTION**



**SNF**  
 CM 4,5 X 60 X 215 H

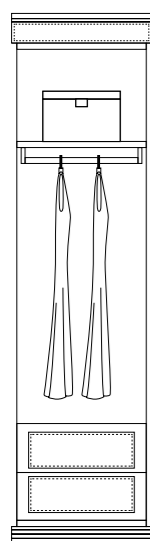

**SN104 senza anta**  
**SNV104 anta vetro**  
**SNL104 anta legno**  
 CM 60 X 60 X 235,5 H

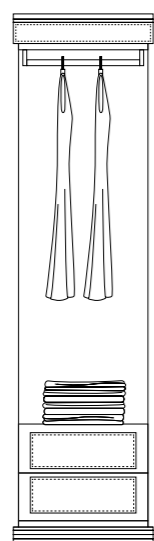

**SN105 senza anta**  
**SNV105 anta vetro**  
**SNL105 anta legno**  
 CM 60 X 60 X 235,5 H

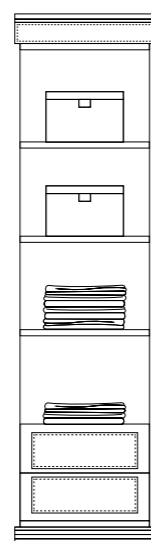

**SN106 senza anta**  
**SNV106 anta vetro**  
**SNL106 anta legno**  
 CM 60 X 60 X 235,5 H

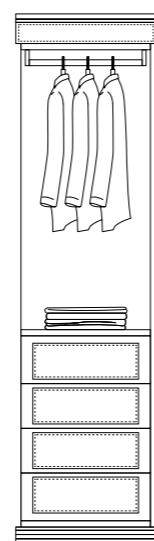

**SN107 senza anta**  
**SNV107 anta vetro**  
**SNL107 anta legno**  
 CM 60 X 60 X 235,5 H

**ELEMENTO ANGOLARE | CORNER ELEMENT**

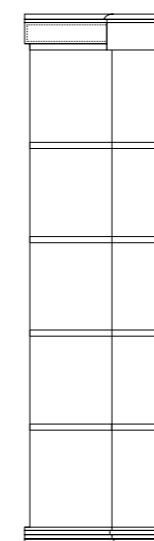

**SN111 senza anta**  
**SNV111 anta vetro**  
**SNL111 anta legno**  
 CM 93 X 93 X 235,5 H

**ELEMENTI TERMINALI CURVI | TERMINAL CURVED ELEMENTS**

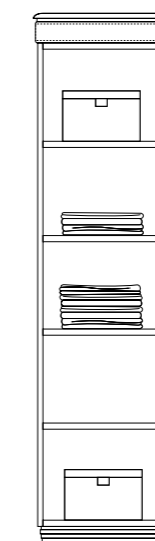

**SNL109 SX anta legno**  
 CM 57 X 60 X 235,5 H

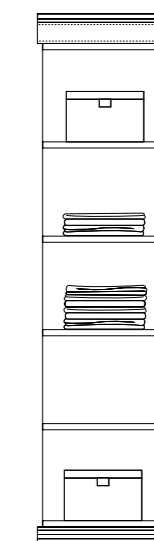

**SNL110 DX anta legno**  
 CM 57 X 60 X 235,5 H

I moduli SN100, SN101, SN102, SN103, SN104, SN105, SN106, SN107, SN108 aumentano la misura del top di 2 cm per lato quando sono terminali non incassati  
 The modules S001, S002, S006, S007, S008, S009 that increase the size of the top by 2 cm per side when they are not recessed terminals



**ELEMENTI NOTTE 120 | NIGHT ELEMENTS 120**  
 PROFONDITÀ DEPTH 60 CM | ALTEZZA HEIGHT 235 CM

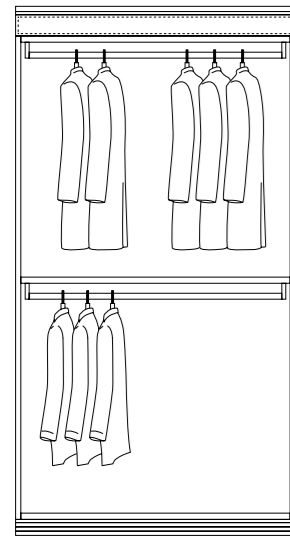

SN130 senza anta  
 SNV130 anta vetro  
 SNL130 anta legno  
 CM 120 X 60 X 235,5 H

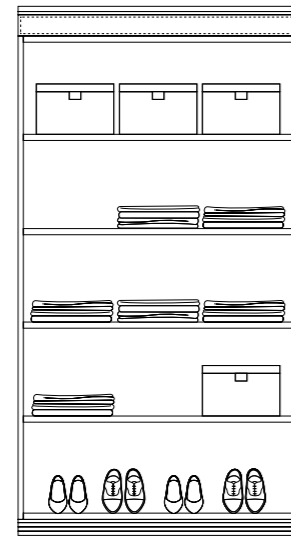

SN131 senza anta  
 SNV131 anta vetro  
 SNL131 anta legno  
 CM 120 X 60 X 235,5 H

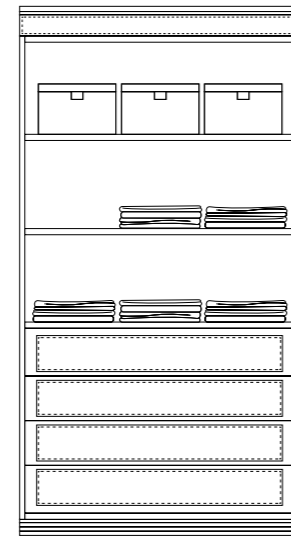

SN132 senza anta  
 SNV132 anta vetro  
 SNL132 anta legno  
 CM 120 X 60 X 235,5 H

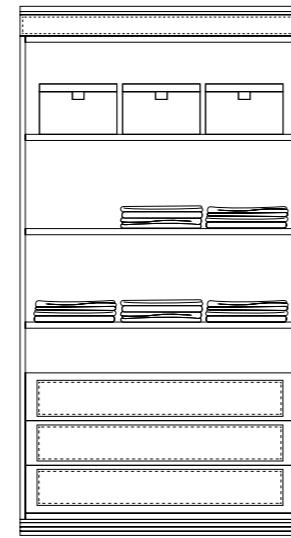

SN133 senza anta  
 SNV133 anta vetro  
 SNL133 anta legno  
 CM 120 X 60 X 235,5 H

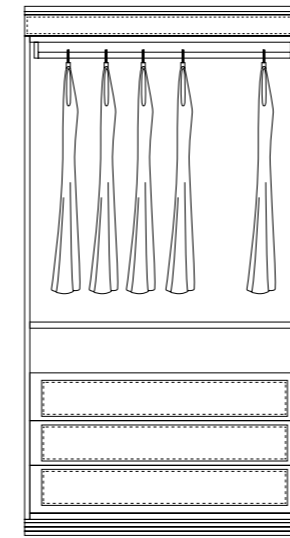

SN138 senza anta  
 SNV138 anta vetro  
 SNL138 anta legno  
 CM 120 X 60 X 235,5 H

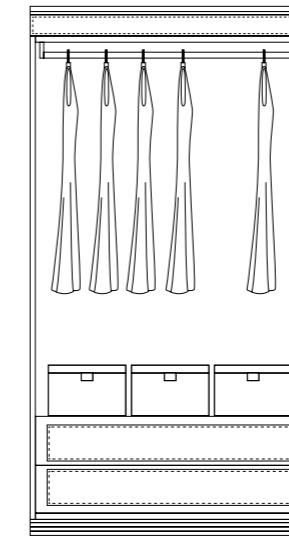

SN139 senza anta  
 SNV139 anta vetro  
 SNL139 anta legno  
 CM 120 X 60 X 235,5 H

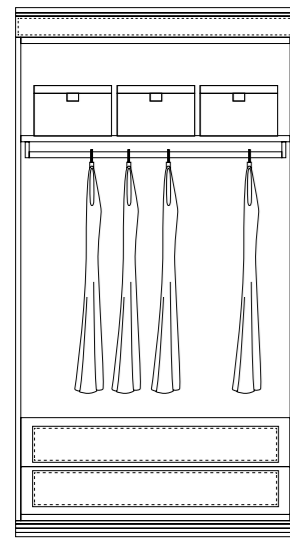

SN134 senza anta  
 SNV134 anta vetro  
 SNL134 anta legno  
 CM 120 X 60 X 235,5 H

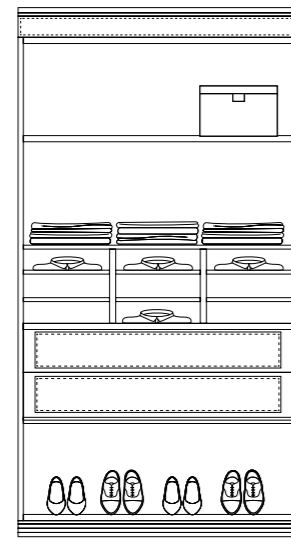

SN135 senza anta  
 SNV135 anta vetro  
 SNL135 anta legno  
 CM 120 X 60 X 235,5 H

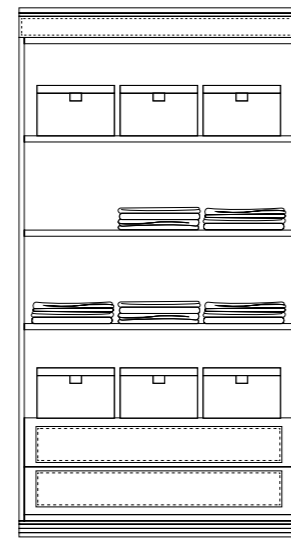

SN136 senza anta  
 SNV136 anta vetro  
 SNL136 anta legno  
 CM 120 X 60 X 235,5 H

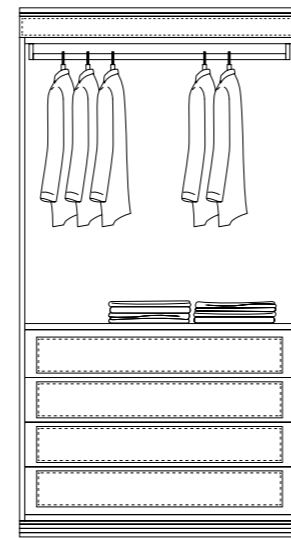

SN137 senza anta  
 SNV137 anta vetro  
 SNL137 anta legno  
 CM 120 X 60 X 235,5 H

I moduli sopra indicati aumentano la misura del top di 2 cm per lato quando sono terminali non incassati  
 The modules indicated above cm the measure of the top of 2 sides when they are non-recessed terminals



## ELEMENTI BOISERIE | BOISERIE ELEMENTS

### ELEMENTI TERMINALI | TERMINAL ELEMENTS

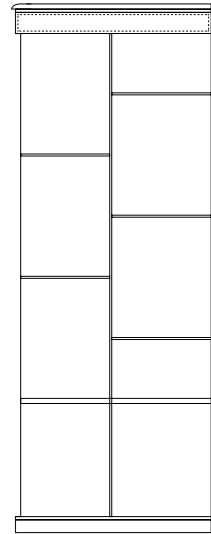

**SB001-SX**  
CM 87,25 X 4,5 X 235,5 H

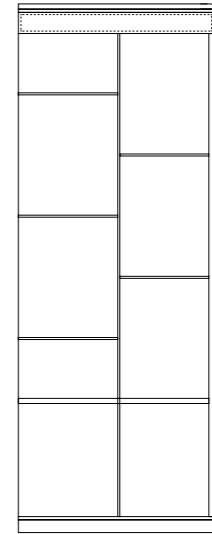

**SB001-DX**  
CM 87,25 X 4,5 X 235,5 H

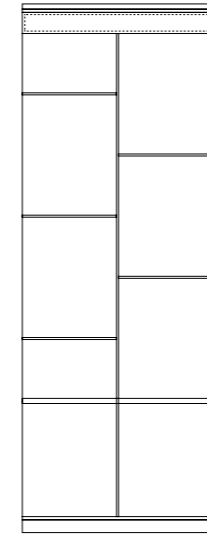

**SB001-CX**  
CM 84,5 X 4,5 X 235,5 H

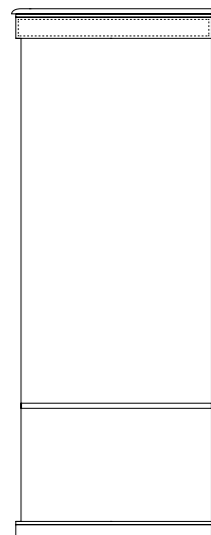

**SB002-SX**  
CM 87,25 X 4,5 X 235,5 H

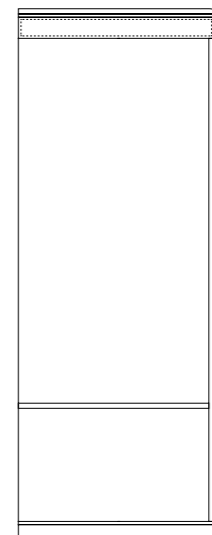

**SB002-DX**  
CM 87,25 X 4,5 X 235,5 H



**SB002-CX**  
CM 84,5 X 4,5 X 235,5 H

### ELEMENTI CENTRALI | CENTRAL ELEMENTS

### ELEMENTO PER CONNESSIONE | ELEMENT FOR CONNECTION



**SB**  
CM 4,5 X 2 X 215 H



**SB/P  
TERMINALE  
TERMINAL**  
CM 4,5 X 6,5 X 215 H

### SCHEMA MONTAGGIO BOISERIE | BOISERIE ASSEMBLY DIAGRAM

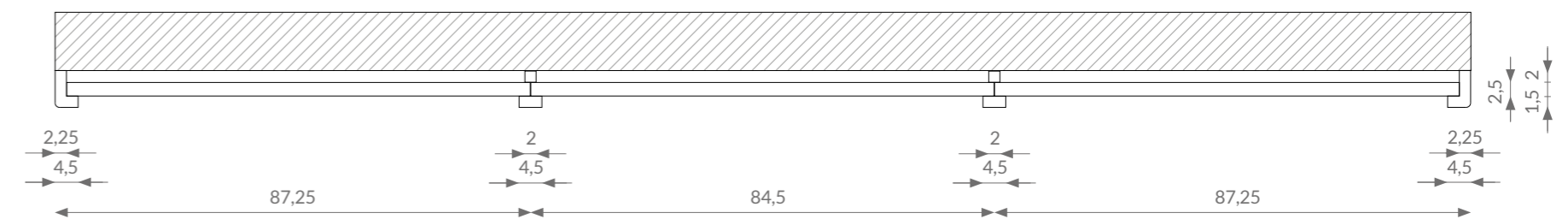



## MENSOLE IN VETRO | GLASS SHELF



**MGV060**  
cm 60 x 46



**MGV0120**  
cm 120 x 46



**MGV0180**  
cm 180 x 46



**MGV0225**  
cm 225 x 46

## SOSTEGNO PER MENSOLA | SUPPORT FOR SHELF



**SM**  
cm 1.3 x 44 x 20 h

## MENSOLA IN LEGNO | WOODEN SHELF



**MGL060**  
cm 60 x 46

**MNL060**  
cm 60 x 60

## PORTA CAMICIE | SHIRT HOLDER

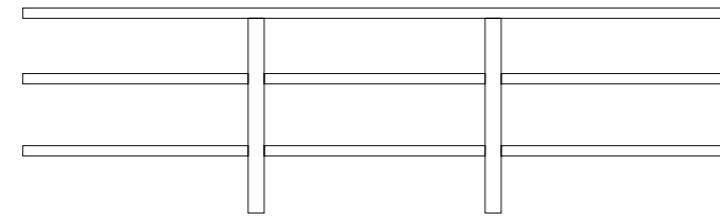

**PC0120**  
cm 120 x 60



**MGL0120**  
cm 120 x 46

**MNL0120**  
cm 120 x 60

## BASTONE APPENDIABITI | CLOTHES HANGER STICK

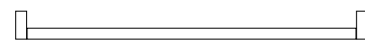

**BA060**  
cm 60

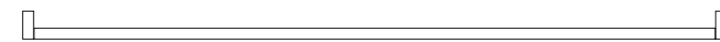

**BA0120**  
cm 120

## ELEMENTI GIORNO | DAY ELEMENTS

### ANTE 60 | DOORS 60

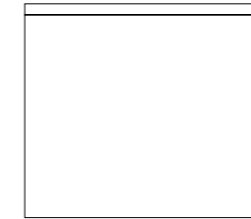

**A060**  
cm 60 x 3 x 52,5 h

### CASSETTIERE GIORNO 60 | DAY DRAWERS 60

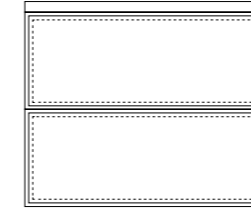

**CG060/2**  
cm 60 x 46 x 52,5 h



ELEMENTI NOTTE | NIGHT ELEMENTS

CASSETTIERE NOTTE 60 | NIGHT DRAWERS 60

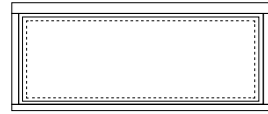

**CN060/1**  
cm 60 x 60 x 22,75 h

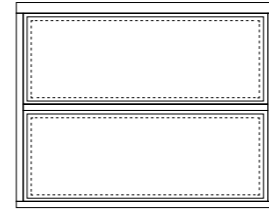

**CN060/2**  
cm 60 x 60 x 42,5 h

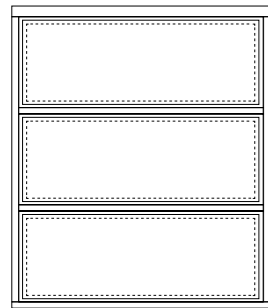

**CN060/3**  
cm 60 x 60 x 62,25 h

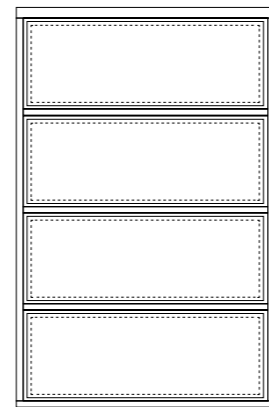

**CN060/4**  
cm 60 x 60 x 82 h

CASSETTIERE NOTTE 120 | NIGHT DRAWERS 120

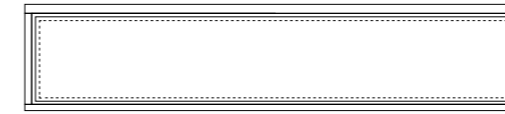

**CN0120/1**  
cm 120 x 60 x 22,75 h

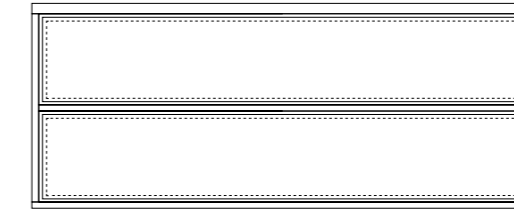

**CN0120/2**  
cm 120 x 60 x 42,5 h

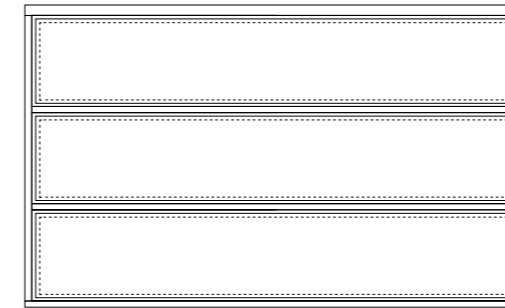

**CN0120/3**  
cm 120 x 60 x 62,25 h



**CN0120/4**  
cm 120 x 60 x 82 h



ELEMENTS

ELEMENTS





DIVANO | SOFÀ

**0300 RICHARD**  
CM 280 X 92 X 82 H  
**0300/S RICHARD**  
CM 240 X 92 X 82 H  
**0300/L RICHARD**  
CM 220 X 92 X 82 H

**STRUTTURA / SEDUTA** Telaio in legno con imbottitura in poliuretano espanso a densità differenziate. Seduta con cinghie elastiche  
**CUSCINATURA** Gomma con strato superiore in memory  
**RIVESTIMENTO** Tessuto o pelle. Rivestimento su scocca con trapuntatura  
**BASAMENTO** Legno rivestito in metallo

**STRUCTURE / SEAT** Wooden frame with differentiated density polyurethane foam padding. Seat with interwoven elastic bealt  
**CUSHIONS SEAT** Rubber with upper layer in memory foam  
**COVER** Fabric or leather. Quilted upholstery on the external structure  
**BASE** Wooden base covered in metal



DIVANO | SOFÀ

**0302/B KELVIN** Profilo diverso colore | Details different colour  
CM 280 X 90 X 85 H  
**0302 KELVIN**  
CM 260 X 90 X 85 H  
**0302/S KELVIN**  
CM 220 X 90 X 85 H

**STRUTTURA / SEDUTA** Telaio in legno con imbottitura in poliuretano espanso a densità differenziate. Seduta con cinghie elastiche  
**CUSCINATURA** Gomma con strato superiore in memory  
**RIVESTIMENTO** Tessuto o pelle  
**BASAMENTO** Legno con profilo in metallo

**STRUCTURE / SEAT** Wooden frame with differentiated density polyurethane foam padding. Seat with interwoven elastic bealt  
**CUSHIONS SEAT** Rubber with upper layer in memory foam  
**COVER** Fabric or leather  
**BASE** Wooden base with metal profile



DIVANO | SOFÀ

**0304 GEORGE**  
CM 270 X 100 X 90 H  
**0304/S GEORGE**  
CM 230 X 100 X 90 H

**STRUTTURA / SEDUTA** Telaio in legno con imbottitura in poliuretano espanso a densità differenziate. Seduta con cinghie elastiche  
**CUSCINATURA** Gomma con strato superiore in memory  
**RIVESTIMENTO** Tessuto o pelle  
**BASAMENTO** Legno con profilo in metallo

**STRUCTURE / SEAT** Wooden frame with differentiated density polyurethane foam padding. Seat with interwoven elastic bealt  
**CUSHIONS SEAT** Rubber with upper layer in memory foam  
**COVER** Fabric or leather  
**BASE** Wooden base with metal profile



DIVANO | SOFÀ

**0306 FRED**  
CM 240 X 90 X 85 H  
**0306/L FRED**  
CM 280 X 90 X 85 H  
**0306/S FRED**  
CM 220 X 90 X 85 H

**STRUTTURA / SEDUTA** Telaio in legno con imbottitura in poliuretano espanso a densità differenziate. Seduta con cinghie elastiche  
**CUSCINATURA** Gomma con strato superiore in memory  
**RIVESTIMENTO** Tessuto o pelle  
**BASAMENTO** Piedi in metallo

**STRUCTURE / SEAT** Wooden frame with differentiated density polyurethane foam padding. Seat with interwoven elastic bealt  
**CUSHIONS SEAT** Rubber with upper layer in memory foam  
**COVER** Fabric or leather  
**BASE** Metal feet



DIVANO | SOFÀ

**0308 THOMAS**  
CM 273 X 117 X 88 H  
**0308/S THOMAS**  
CM 243 X 117 X 88 H

**STRUTTURA / SEDUTA** Telaio in legno con imbottitura in poliuretano espanso a densità differenziate  
**CUSCINATURA** Gomma con strato superiore in memory  
**RIVESTIMENTO** Tessuto o pelle. Rivestimento su scocca con trapuntatura a rombi  
**BASAMENTO** Acciaio

**STRUCTURE / SEAT** Wooden frame with differentiated density polyurethane foam padding. Seat with interwoven elastic bealt  
**CUSHIONS SEAT** Rubber with upper layer in memory foam  
**COVER** Fabric or leather. Diamond-quilted upholstery on the external structure  
**BASE** Steel



DIVANO | SOFÀ

**0314 OSCAR**  
CM 255 X 86 X 77 H

**STRUTTURA / SEDUTA** Telaio in legno con imbottitura in poliuretano espanso a densità differenziate.  
**CUSCINATURA** Gomma con strato superiore in memory  
**RIVESTIMENTO** Tessuto o pelle. Lavorazione capitonnè  
**BASAMENTO** Acciaio

**STRUCTURE / SEAT** Wooden frame with differentiated density polyurethane foam padding.  
**CUSHIONS SEAT** Rubber with upper layer in memory foam  
**COVER** Fabric or leather. Quilted with capitonnè motive  
**BASE** Steel



DIVANO | SOFÀ

**0310 RUPERT**  
CM 273 X 117 X 88 H  
**0310/S RUPERT**  
CM 243 X 117 X 88 H

**STRUTTURA / SEDUTA** Telaio in legno con imbottitura in poliuretano espanso a densità differenziate  
**CUSCINATURA** Gomma con strato superiore in memory  
**RIVESTIMENTO** Tessuto o pelle  
**BASAMENTO** Acciaio

**STRUCTURE / SEAT** Wooden frame with differentiated density polyurethane foam padding.  
**CUSHIONS SEAT** Rubber with upper layer in memory foam  
**COVER** Fabric or leather.  
**BASE** Steel



DIVANO | SOFÀ

**0312 OLIVER**  
CM 240 X 95 X 82 H  
**0312/L OLIVER**  
CM 280 X 95 X 92 H

**STRUTTURA / SEDUTA** Telaio in legno con imbottitura in poliuretano espanso a densità differenziate.  
**CUSCINATURA** Gomma con strato superiore in memory  
**RIVESTIMENTO** Tessuto o pelle. Lavorazione cannettè  
**BASAMENTO** Acciaio

**STRUCTURE / SEAT** Wooden frame with differentiated density polyurethane foam padding.  
**CUSHIONS SEAT** Rubber with upper layer in memory foam  
**COVER** Fabric or leather. Quilted with cannettè motive  
**BASE** Steel





DIVANO | SOFÀ  
**0330 GENTLEMEN**  
 CM 307 X 307 X 76 H

**STRUTTURA / SEDUTA** Telaio in legno con imbottitura in poliuretano espanso a densità differenziate. Seduta con cinghie elastiche  
**CUSCINATURA** Gomma con strato superiore in memory  
**RIVESTIMENTO** Tessuto o pelle

**STRUCTURE / SEAT** Wooden frame with differentiated density polyurethane foam padding. Seat with interwoven elastic bealt  
**CUSHIONS SEAT** Rubber with upper layer in memory foam  
**COVER** Fabric or leather

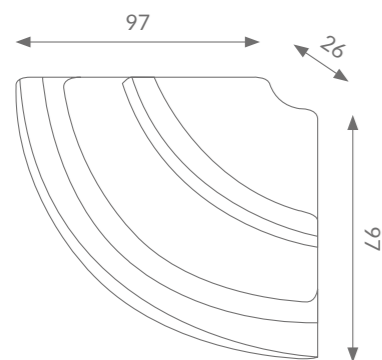

DIVANO | SOFÀ  
**0330/7**  
 CM 120 X 120 X 76 H

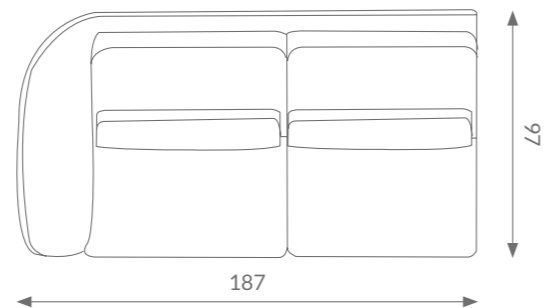

DIVANO | SOFÀ  
**0330/1**  
 CM 187 X 97 X 76 H

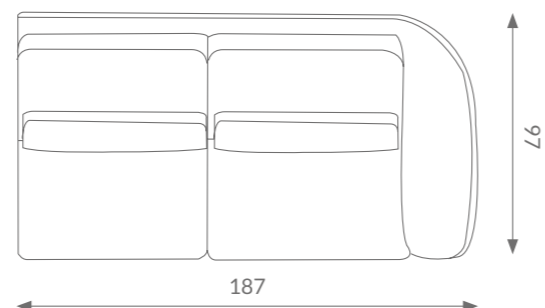

DIVANO | SOFÀ  
**0330/2**  
 CM 187 X 97 X 76 H

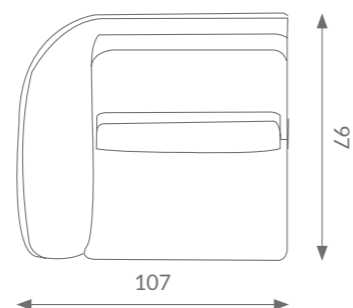

DIVANO | SOFÀ  
**0330/3**  
 CM 107 X 97 X 76 H

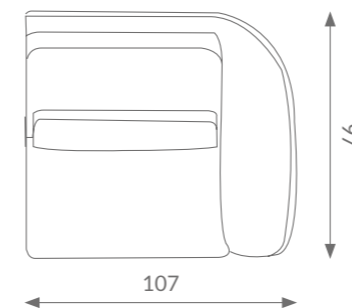

DIVANO | SOFÀ  
**0330/4**  
 CM 107 X 97 X 76 H

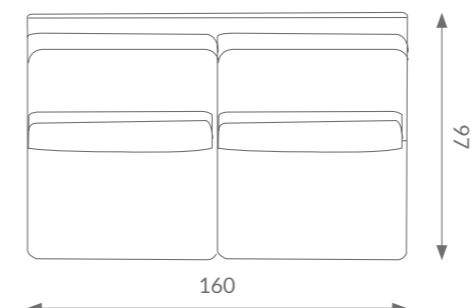

DIVANO | SOFÀ  
**0330/5**  
 CM 160 X 97 X 76 H

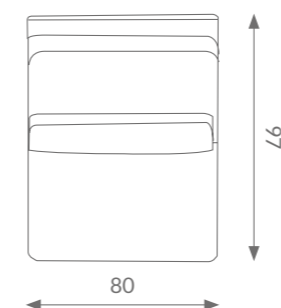

DIVANO | SOFÀ  
**0330/6**  
 CM 80 X 97 X 76 H



POUFF | POUFFE  
**0381 ERIK**  
 CM 110 X 55 X 36 H

**STRUTTURA** Telaio in legno con imbottitura in poliuretano espanso a densità differenziate  
**RIVESTIMENTO** Tessuto o pelle  
**BASAMENTO** Legno rivestito in metallo

**STRUCTURE** Wooden frame with differentiated density polyurethane foam padding  
**COVER** Fabric or leather  
**BASE** Wooden base covered with metal

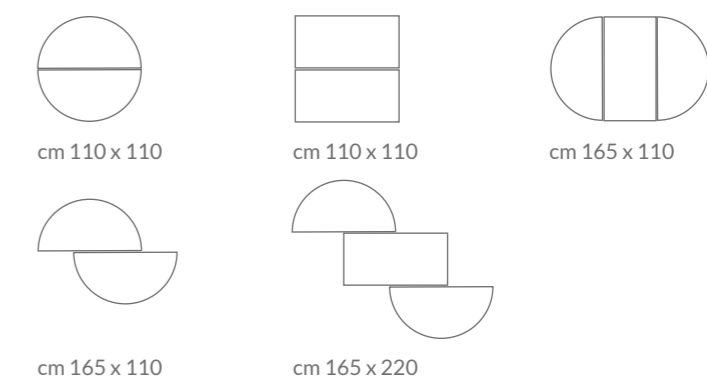

POUFF | POUFFE  
**0380 ERIK**  
 CM 110 X 55 X 36 H

**STRUTTURA** Telaio in legno con imbottitura in poliuretano espanso a densità differenziate  
**RIVESTIMENTO** Tessuto o pelle  
**BASAMENTO** Legno rivestito in metallo

**STRUCTURE** Wooden frame with differentiated density polyurethane foam padding  
**COVER** Fabric or leather  
**BASE** Wooden base covered with metal





POLTRONA | ARMCHAIR

**0301 AMY**  
CM 110 X 92 X 82 H

**STRUTTURA / SEDUTA** Telaio in legno con imbottitura in poliuretano espanso a densità differenziate. Seduta con cinghie elastiche

**CUSCINATURA** Gomma con strato superiore in memory

**RIVESTIMENTO** Tessuto o pelle. Rivestimento su scocca con trapuntatura

**BASAMENTO** Legno rivestito in metallo

**STRUCTURE / SEAT** Wooden frame with differentiated density polyurethane foam padding. Seat with interwoven elastic bealt

**CUSHIONS SEAT** Rubber with upper layer in memory foam

**COVER** Fabric or leather. Quilted upholstery on the external structure

**BASE** Wooden base covered in metal profile



POLTRONA | ARMCHAIR

**0305 GEORGIA**  
CM 100 X 100 X 90 H

**STRUTTURA / SEDUTA** Telaio in legno con imbottitura in poliuretano espanso a densità differenziate. Seduta con cinghie elastiche

**CUSCINATURA** Gomma con strato superiore in memory

**RIVESTIMENTO** Tessuto o pelle

**BASAMENTO** Legno con profilo in metallo

**STRUCTURE / SEAT** Wooden frame with differentiated density polyurethane foam padding. Seat with interwoven elastic bealt

**CUSHIONS SEAT** Rubber with upper layer in memory foam

**COVER** Fabric or leather

**BASE** Wooden base with metal profile



POLTRONA | ARMCHAIR

**0309 JACQUARD**  
CM 81 X 78 X 74 H

**STRUTTURA / SEDUTA** Telaio in metallo con imbottitura in poliuretano espanso a densità differenziate

**CUSCINATURA / SCHIENALE** Gomma con strato superiore in memory

**RIVESTIMENTO** Tessuto o pelle

**STRUCTURE / SEAT** Metal frame with differentiated density polyurethane foam padding

**SEAT / BACK CUSHION** Rubber with upper layer in memory foam

**COVER** Fabric or leather



POLTRONA | ARMCHAIR

**0313 CHIFFON**  
CM 89 X 85 X 122 H

**STRUTTURA / SEDUTA** Telaio in metallo con imbottitura in poliuretano espanso a densità differenziate

**CUSCINATURA / SCHIENALE** Gomma con strato superiore in memory

**RIVESTIMENTO** Tessuto o pelle

**STRUCTURE / SEAT** Metal frame with differentiated density polyurethane foam padding

**SEAT / BACK CUSHION** Rubber with upper layer in memory foam

**COVER** Fabric or leather



POLTRONA | ARMCHAIR

**0303/B KAROLIN** Profilo diverso colore | Details different colour  
CM 105 X 90 X 85 H

**0303 KAROLIN**  
CM 105 X 90 X 85 H

**STRUTTURA / SEDUTA** Telaio in legno con imbottitura in poliuretano espanso a densità differenziate. Seduta con cinghie elastiche

**CUSCINATURA** Gomma con strato superiore in memory

**RIVESTIMENTO** Tessuto o pelle

**BASAMENTO** In legno con profilo in metallo

**STRUCTURE / SEAT** Wooden frame with differentiated density polyurethane foam padding. Seat with interwoven elastic bealt

**CUSHIONS SEAT** Rubber with upper layer in memory foam

**COVER** Fabric or leather

**BASE** Wooden base with metal profile



POLTRONA | ARMCHAIR

**0307 FANNY**  
CM 103 X 90 X 85 H

**STRUTTURA / SEDUTA** Telaio in legno con imbottitura in poliuretano espanso a densità differenziate. Seduta con cinghie elastiche

**CUSCINATURA** Gomma con strato superiore in memory

**RIVESTIMENTO** Tessuto o pelle

**BASAMENTO** Piedi in metallo

**STRUCTURE / SEAT** Wooden frame with differentiated density polyurethane foam padding. Seat with interwoven elastic bealt

**CUSHIONS SEAT** Rubber with upper layer in memory foam

**COVER** Fabric or leather

**BASE** Metal feet



POLTRONA | ARMCHAIR

**0311 ALYSON**  
CM 99 X 83 X 82 H

**STRUTTURA / SEDUTA** Telaio in metallo e legno con imbottitura in poliuretano espanso a densità differenziate

**CUSCINATURA / SCHIENALE** Gomma con strato superiore in memory

**RIVESTIMENTO** Tessuto o pelle

**STRUCTURE / SEAT** Metal and wooden frame with differentiated density polyurethane foam padding

**SEAT / BACK CUSHION** Rubber with upper layer in memory foam

**COVER** Fabric or leather





TAVOLINO | COFFEE TABLE

**0546 ZOE**  
CM Ø 70 X 60 H  
**0547 CHLOÉ**  
CM Ø 70 X 38 H  
**0548 JADE**  
CM Ø 50 X 50 H

**TOP** Legno con bordo sagomato, impiallacciato o laccato, oppure in marmo. Dettagli in metallo. Sottotop in legno rivestito con pelle o tessuto  
**GAMBE** Legno oppure metallo

**TOP** Wood with shaped edge, veneered or lacquered. Also available with marble top. Metal detail. Curved under wood top covered with leather or fabric  
**LEGS** Wood or metal



TAVOLINO | COFFEE TABLE

**0543 CALVIN** Con cassetto | With drawer  
CM Ø 100 X 25 H  
**0544 CARL**  
CM Ø 80 X 40 H  
**0545 CLAY**  
CM Ø 50 X 55 H

**STRUTTURA** Legno curvato impiallacciato o laccato  
**TOP** Legno con specchio fumè o bronzo oppure marmo o laminam. Disponibile anche in legno impiallacciato o laccato. Dettagli in metallo  
**CASSETTO** Interno legno laccato e rivestito in microfibra, apertura con sistema push-pull

**STRUCTURE** Curved wood veneered or lacquered  
**TOP** Wood covered with mirror smoke grey or bronze or marble or laminam. Also available veneered or lacquered. Metal detail  
**DRAWERS** Internal in lacquered wood and with microfiber cover, push-pull opening system



TAVOLINO | COFFEE TABLE

**0549 DESNY**  
CM 130 X 80 X 40 H

**TOP** Legno con bordo sagomato, impiallacciato o laccato, oppure in marmo. Dettagli in metallo. Sottotop in legno rivestito con pelle o tessuto  
**BASE** Legno sagomato

**TOP** Wood with shaped edge, veneered or lacquered. Also available with marble top. Metal detail. Curved under wood top covered with leather or fabric  
**BASE** Shaped wood



TAVOLINO | COFFEE TABLE

**0540 ABHRAN**  
CM Ø 70 X 60 H  
**0541 ALLEN**  
CM Ø 70 X 38 H  
**0542 ARNOLD**  
CM Ø 50 X 50 H

**TOP** Legno con bordo sagomato laccato oppure impiallacciato. È possibile anche in marmo. Dettagli in metallo  
**GAMBE** Legno con dettagli in metallo

**TOP** Wood with shaped edge lacquered or veneered. Also available with marble top. Metal details.  
**LEGS** Wood with metal details



TAVOLINO | COFFEE TABLE

**0553 ELAN**  
CM Ø 60 X 50 H  
**0554 CIRCLE**  
CM Ø 130 X 32 H

**TOP** Struttura in legno con bordo sagomato rivestito in pelle. Top laminam, marmo o specchio. Disponibile anche in legno impiallacciato o laccato  
**GAMBE** Legno con dettagli in metallo

**TOP** Wooden structure with shaped edge, covered in leather. Top with laminam, marble or mirror. Also available veneered or lacquered  
**LEGS** Wood with metal details



TAVOLINO | COFFEE TABLE

**0550 TRENDY**  
CM Ø 70 X 60 H  
**0551 DERBY**  
CM Ø 70 X 38 H  
**0552 DUNE**  
CM Ø 50 X 50 H

**TOP** Laminam con sottotop in legno  
**GAMBE** Legno con dettagli in metallo

**TOP** Laminam with under wood top  
**LEGS** Wood with metal details



TAVOLINO | COFFEE TABLE

**0557 KENDO**  
CM Ø 140 X 38 H

**TOP** Vetro trasparente disponibile anche in legno impiallacciato o laccato, marmo o laminam  
**BASE** Legno curvato impiallacciato o laccato oppure rivestito in pelle o tessuto

**TOP** Transparent glass also available veneered or lacquered, marble or laminam  
**BASE** Curved wood covered with leather or fabric



TAVOLINO | COFFEE TABLE

**0555 PICK**  
CM Ø 109 X 106 X 42 H  
**0556 SURF**  
CM Ø 150 X 65 X 30 H

**TOP** Laminam con sottotop in legno  
**GAMBE** Legno con dettagli in metallo

**TOP** Laminam with under wood top  
**LEGS** Wood with metal details

*Le guide e le cerniere sono con meccanismo soft. Soft closing for runners and hinges*





CONSOLLE | CONSOLE

**0110 ELISABETH**  
CM 140 X 45 X 75 H

**TOP** Legno sagomato, laccato oppure impiallacciato. Disponibile anche in marmo. Dettagli in metallo

**BASE** Legno sagomato

**TOP** Shaped wood, lacquered or veneered. Also available with marble top. Metal detail  
**BASE** Shaped wood



CONSOLLE | CONSOLE

**0116 TAY**  
CM 130 X 41 X 75 H

**STRUTTURA** Legno impiallacciato o laccato

**TOP** Laminam o specchio o legno

**CASSETTI** Legno impiallacciato o laccato. Interno legno laccato e rivestito in microfibra, apertura con sistema push-pull

**BASE** Metallo

**STRUCTURE** Wood veneered or lacquered

**TOP** Laminam or mirror or wood

**DRAWERS** Frontal drawers wood veneered or lacquered. Internal drawers in lacquered wood and with microfiber cover, push-pull opening system

**BASE** Metal



CONSOLLE | CONSOLE

**0114 CHANEL**  
CM 130 X 41 X 75 H

**STRUTTURA** Metallo

**TOP** Legno impiallacciato o laccato con dettaglio marmo

**STRUCTURE** Metal

**TOP** Wood veneered or lacquered with marble detail



SCRITTOIO 2 cassetti | DESK 2 drawers

**0112 ALEX**  
CM 140 X 52 X 78 H

**STRUTTURA** Legno curvato impiallacciato o laccato. Dettagli metallo

**TOP** Legno con bordo sagomato, impiallacciato o laccato, oppure in marmo. Sottotop in legno rivestito con pelle o tessuto

**CASSETTI** Legno con frontali rivestiti in pelle o tessuto. Interno legno laccato e rivestito in microfibra, apertura con sistema push-pull

**BASE** Legno sagomato

**STRUCTURE** Curved wood veneered or lacquered. Metal details

**TOP** Wood with shaped edge, veneered or lacquered. Also available with marble top. Curved under wood top covered with leather or fabric

**DRAWERS** Frontal drawers wood covered in leather or fabric. Internal drawers in lacquered wood and with microfiber cover, push-pull opening system

**BASE** Shaped wood



CONSOLLE 2 cassetti | CONSOLE 2 drawers

**0113 MOLLY**  
CM 130 X 46 X 78 H

**STRUTTURA** Legno curvato impiallacciato o laccato. Dettagli metallo

**TOP** Legno con bordo sagomato, impiallacciato o laccato, oppure in marmo. Sottotop in legno rivestito con pelle o tessuto

**CASSETTI** Legno con frontali rivestiti in pelle o tessuto. Interno legno laccato e rivestito in microfibra, apertura con sistema push-pull

**BASE** Legno sagomato

**STRUCTURE** Curved wood veneered or lacquered. Metal details

**TOP** Wood with shaped edge, veneered or lacquered. Also available with marble top. Curved under wood top covered with leather or fabric

**DRAWERS** Frontal drawers wood covered in leather or fabric. Internal drawers in lacquered wood and with microfiber cover, push-pull opening system

**BASE** Shaped wood



MOBILE BAR | BAR CABINET

**0140 FELIX**  
CM 100 X 52 X 155 H

**STRUTTURA** Legno curvato impiallacciato o laccato anche internamente. Dettagli metallo.

Interno mobile con illuminazione led e schienale specchio

**TOP** Legno con bordo sagomato, impiallacciato o laccato, oppure in marmo. Sottotop curvo in legno rivestito con pelle o tessuto

**BASE** Legno sagomato

**MANIGLIE** Acciaio

**STRUCTURE** Curved wood veneered or lacquered also internally. Metal details. Inner with led lighting and backrest mirror

**TOP** Wood with shaped edge, veneered or lacquered. Also available with marble top. Under the top curved wood covered with leather or fabric

**BASE** Shaped wood

**HANDLES** Steel

*Le guide e le cerniere sono con meccanismo soft. Soft closing for runners and hinges*





PORTA TV | TV CABINET  
**0130 DEAN**  
CM 230 X 48 X 52 H

**STRUTTURA** Legno impiallacciato o laccato. Particolari in legno disegno cannettè  
**CASSETTI** Legno con frontali rivestiti in pelle o tessuto. Interno legno laccato e rivestito in microfibra  
**BASE** Legno con finitura metallica

**STRUCTURE** Wood veneered or lacquered. Cannettè details in wood  
**DRAWERS** Frontal drawers wood covered in leather or fabric. Internal drawers in lacquered wood and with microfiber cover  
**BASE** Solid wood with metallic finishing



PORTA TV | TV CABINET  
**0131 GINGER**  
CM 190 X 52 X 65 H

**STRUTTURA** Legno curvato impiallacciato o laccato. Dettagli in metallo  
**TOP** Legno con bordo sagomato, impiallacciato o laccato, oppure in marmo. Sottotop in legno rivestito con pelle o tessuto  
**BASE** Legno sagomato  
**MANIGLIE** Acciaio

**STRUCTURE** Curved wood veneered or lacquered. Metal details  
**TOP** Wood with shaped edge, veneered or lacquered. Also available with marble top. Curved under wood top covered with leather or fabric  
**BASE** Shaped wood  
**HANDLES** Steel

*Le guide e le cerniere sono con meccanismo soft. Soft closing for runners and hinges*



PORTA TV | TV CABINET  
**0134 HAMILTON**  
CM 220 X 40 X 49,5 H

**STRUTTURA** Legno curvato impiallacciato o laccato. Particolari in legno disegno cannettè. Dettagli metallo  
**TOP** Marmo o laminam. Disponibile anche in legno impiallacciato o laccato  
**BASE** Legno

**STRUCTURE** Curved wood veneered or lacquered. Cannettè details in wood. Metal details  
**TOP** Marble or laminam. Also available with wood veneered or lacquered  
**BASE** Solid wood



PORTA TV | TV CABINET  
**0135 ASCOT**  
CM 205 X 50 X 50 H

**STRUTTURA** Legno curvato impiallacciato o laccato. Dettagli metallo  
**TOP** Marmo o laminam. Disponibile anche in legno impiallacciato o laccato  
**CASSETTI** Legno impiallacciato o laccato. Interno legno laccato e rivestito in microfibra, apertura con sistema push-pull  
**BASE** Legno

**STRUCTURE** Curved wood veneered or lacquered. Metal details  
**TOP** Marble or laminam. Also available with wood veneered or lacquered  
**DRAWERS** Frontal drawers wood veneered or lacquered. Internal drawers in lacquered wood and with microfiber cover, push-pull opening system  
**BASE** Solid wood



PANNELLO PORTA TV | TV PANEL  
**0132 KENT**  
CM 165 X 2 X 105 H

**STRUTTURA** Pannello legno rivestito in pelle o tessuto  
**STRUCTURE** Wood panel covered in leather or fabric



PANNELLO PORTA TV | TV PANEL  
**0136 ARI**  
CM 180 X 21 X 140 H

**STRUTTURA** Legno curvato rivestito in pelle o tessuto con illuminazione led  
**OPTIONAL** Foro per cavi tv  
**STRUCTURE** Curved wood covered in leather or fabric with led lighting  
**OPTIONAL** Hole for tv cable





SCRIVANIA | DESK  
**0180 TECH**  
CM 205 X 85 X 75 H

**STRUTTURA** Legno curvato impiallacciato o laccato. Dettagli in metallo  
**TOP** Legno con bordo sagomato impiallacciato o laccato. Inserti in pelle o tessuto. Sottotop in legno rivestito in pelle o tessuto  
**CASSETTI** Legno impiallacciato o laccato con frontali rivestiti in pelle o tessuto. Interno in legno laccato rivestito in microfibra. Apertura con sistema push-pull  
**BASE** Legno sagomato

**STRUCTURE** Curved wood veneered or lacquered. Metal details  
**TOP** Wood with shaped edge, veneered or lacquered. Inserts in leather or fabric. Curved under wood top covered with leather or fabric  
**DRAWERS** Frontal drawers wood veneered or lacquered covered in leather or fabric. Internal drawers in lacquered wood with microfiber cover. Push-pull opening system  
**BASE** Shaped wood



SCRIVANIA | DESK  
**0181 SCRIBE**  
CM 240 X 90 X 73 H

**STRUTTURA** Legno curvato impiallacciato o laccato con inserti in pelle o tessuto. Fianco laterale apribile  
**TOP** Legno con bordo sagomato impiallacciato o laccato. Inserti in pelle o tessuto. Sottotop in metallo  
**CASSETTI** Legno impiallacciato o laccato con frontali rivestiti in pelle o tessuto. Interno in legno laccato rivestito in microfibra. Apertura con sistema push-pull  
**BASE** Metallo

**STRUCTURE** Curved wood veneered or lacquered with leather or fabric inserts. Side panel that can be opened  
**TOP** Wood with shaped edge, veneered or lacquered. Inserts in leather or fabric. Metal curved under wood top  
**DRAWERS** Frontal drawers wood veneered or lacquered covered in leather or fabric. Internal drawers in lacquered wood with microfiber cover. Push-pull opening system  
**BASE** Metal

*Le guide e le cerniere sono con meccanismo soft. Soft closing for runners and hinges*



SCRIVANIA | DESK  
**0182 PIXEL**  
CM 240 X 90 X 73 H

**STRUTTURA** Legno curvato impiallacciato o laccato con inserti in pelle o tessuto. Fianco laterale apribile  
**TOP** Legno con bordo sagomato impiallacciato o laccato. Inserti in pelle o tessuto. Sottotop in metallo  
**CASSETTI** Legno impiallacciato o laccato con frontali rivestiti in pelle o tessuto. Interno in legno laccato rivestito in microfibra. Apertura con sistema push-pull  
**BASE** Metallo

**STRUCTURE** Curved wood veneered or lacquered with leather or fabric inserts. Side panel that can be opened  
**TOP** Wood with shaped edge, veneered or lacquered. Inserts in leather or fabric. Metal curved under wood top  
**DRAWERS** Frontal drawers wood veneered or lacquered covered in leather or fabric. Internal drawers in lacquered wood with microfiber cover. Push-pull opening system  
**BASE** Metal



TAVOLO | TABLE  
**0590 BELMONT**  
CM 481 X 120 X 77 H

**STRUTTURA** Legno sagomato rivestito in pelle o tessuto. Inserti in metallo  
**TOP** Legno con bordo sagomato impiallacciato o laccato. Inserti in pelle o tessuto. Sottotop in legno

**STRUCTURE** Shaped wood covered in leather or fabric. Metal inserts  
**TOP** Shaped wood veneered or lacquered. Leather or fabric inserts. Under wood top



POLTRONA | ARMCHAIR  
**0620 ALBERT**  
CM 62 X 62 X 84 H

**STRUTTURA / SEDUTA** Telaio in metallo con imbottitura in poliuretano espanso a densità differenziate  
**CUSCINATURA / SCHIENALE** Gomma con strato superiore in memory  
**RIVESTIMENTO** Tessuto o pelle

**STRUCTURE / SEAT** Metal frame with differentiated density polyurethane foam padding  
**SEAT / BACK CUSHION** Rubber with upper layer in memory foam  
**COVER** Fabric or leather



POLTRONA | ARMCHAIR  
**0622 CLIP**  
CM 60 X 65 X 85 H

**STRUTTURA / SEDUTA** Telaio in legno curvato, imbottitura con gomma a densità differenziate  
**RIVESTIMENTO** Pelle e tessuto con cuciture

**BACKREST/SEAT** Curved wooden frame, padding with differentiated density rubber  
**COVER** Leather and fabric with stitching



POLTRONA | ARMCHAIR  
**0261 MYFAIR**  
CM 68 X 68 X 128÷137 H

**STRUTTURA / SEDUTA** Telaio in metallo con imbottitura in poliuretano espanso a densità differenziate  
**CUSCINATURA / SCHIENALE** Gomma con strato superiore in memory  
**RIVESTIMENTO** Tessuto o pelle

**STRUCTURE / SEAT** Metal frame with differentiated density polyurethane foam padding  
**SEAT / BACK CUSHION** Rubber with upper layer in memory foam  
**COVER** Fabric or leather





CREDENZA | SIDEBOARD  
**0100 MOON**  
CM 150 X 60 X 85 H

**STRUTTURA** Legno curvato impiallacciato o laccato. Dettagli metallo. Dettagli cannettè sulle ante  
**TOP** Legno con bordo sagomato, impiallacciato o laccato, oppure in marmo  
**BASE** Legno sagomato

**STRUCTURE** Curved wood veneered or lacquered. Metal details. Cannettè details on the cabinet doors  
**TOP** Wood with shaped edge, veneered or lacquered. Also available with marble top  
**BASE** Shaped wood



VETRINA | SHOWCASE  
**0201 HELEN**  
CM 118 X 46 X 180 H

**STRUTTURA** Legno curvato impiallacciato o laccato. Dettagli in metallo  
**TOP** Legno con bordo sagomato, impiallacciato o laccato, oppure in marmo. Sottotop in legno rivestito con pelle o tessuto  
**BASE** Legno sagomato  
**MANIGLIE** Acciaio  
**OPTIONAL** Illuminazione led vano interno e con schienale specchio

**STRUCTURE** Curved wood veneered or lacquered. Metal details  
**TOP** Wood with shaped edge, veneered or lacquered. Also available with marble top. Curved under wood top covered with leather or fabric  
**BASE** Shaped wood  
**HANDLES** Steel  
**OPTIONAL** Inner with led lighting and with backrest mirror

*Le guide e le cerniere sono con meccanismo soft. Soft closing for runners and hinges*



CREDENZA | SIDEBOARD  
**0102 LIGHT**  
CM 200 X 60 X 85 H

**STRUTTURA** Legno curvato impiallacciato o laccato. Dettagli metallo. Dettagli cannettè sulle ante  
**TOP** Legno con bordo sagomato, impiallacciato o laccato, oppure in marmo  
**BASE** Legno sagomato

**STRUCTURE** Curved wood veneered or lacquered. Metal details. Cannettè details on the cabinet doors  
**TOP** Wood with shaped edge, veneered or lacquered. Also available with marble top  
**BASE** Shaped wood



CREDENZA | SIDEBOARD  
**0103 JAGO**  
CM 220 X 52 X 87 H

**STRUTTURA** Legno curvato impiallacciato o laccato. Dettagli in metallo  
**TOP** Legno con bordo sagomato, impiallacciato o laccato, oppure in marmo. Sottotop in legno rivestito con pelle o tessuto  
**BASE** Legno sagomato  
**MANIGLIE** Acciaio

**STRUCTURE** Curved wood veneered or lacquered. Metal details  
**TOP** Wood with shaped edge, veneered or lacquered. Also available with marble top. Curved under wood top covered with leather or fabric  
**BASE** Shaped wood  
**HANDLES** Steel



CREDENZA | SIDEBOARD  
**0105 KAIN**  
CM 220 X 50 X 79,5 H

**STRUTTURA** Legno curvato impiallacciato o laccato. Particolari in legno disegno cannettè. Dettagli metallo  
**TOP** Marmo o laminam. Disponibile anche in legno impiallacciato o laccato  
**BASE** Legno

**STRUCTURE** Curved wood veneered or lacquered. Cannettè details in wood. Metal details  
**TOP** Marble or laminam. Also available with wood veneered or lacquered  
**BASE** Wood



CREDENZA | SIDEBOARD  
**0106 RALPH**  
CM 205 X 50 X 80 H

**STRUTTURA** Legno curvato impiallacciato o laccato. Dettagli metallo  
**TOP** Marmo o laminam. Disponibile anche in legno impiallacciato o laccato  
**BASE** Legno

**STRUCTURE** Curved wood veneered or lacquered. Metal details  
**TOP** Marble or laminam. Also available with wood veneered or lacquered  
**BASE** Wood





TAVOLO | TABLE

**0572 MICHEL**  
CM 220 X 110 X 76 H  
**0572/N MICHEL**  
CM 250 X 110 X 76 H  
**0572/K MICHEL**  
CM 300 X 110 X 76 H  
**0572/S MICHEL**  
CM 180 X 110 X 76 H

**STRUTTURA** Gambe in legno sagomato, impiallacciato o laccato. Dettagli in pelle  
**TOP** Marmo o Laminam. Disponibile anche in legno impiallacciato o laccato  
**BASE** Anello e piastra a terra in metallo

**STRUCTURE** Legs in shaped wood, veneered or lacquered. Details in leather  
**TOP** Marble or Laminam. Also available wood with shaped edge, veneered or lacquered  
**BASE** Rings and plate base in metal



TAVOLO | TABLE

**0573 RIDLEY**  
CM Ø 180 X 76 H LAZY SUSAN CM Ø 100  
**0573/S RIDLEY**  
CM Ø 160 X 76 H LAZY SUSAN CM Ø 80

**STRUTTURA** Gambe in legno sagomato, impiallacciato o laccato. Dettagli in pelle  
**TOP** Marmo o Laminam. Disponibile anche in legno impiallacciato o laccato. Lazy Susan al centro  
**BASE** Anello e piastra a terra in metallo

**STRUCTURE** legs in shaped wood, veneered or lacquered. Details in leather  
**TOP** Marble or Laminam. Also available wood with shaped edge, veneered or lacquered. Lazy Susan in the centre  
**BASE** Rings and plate base in metal



TAVOLO | TABLE

**0570 HARRISON**  
CM 220 X 110 X 78 H  
**0570/N HARRISON**  
CM 250 X 110 X 78 H  
**0570/K HARRISON**  
CM 300 X 110 X 78 H  
**0570/S HARRISON**  
CM 180 X 110 X 78 H

**STRUTTURA** Gambe in legno sagomato  
**TOP** Marmo o Laminam. Disponibile anche in legno impiallacciato o laccato  
**BASE** Piatto in legno impiallacciato o laccato, anello in metallo

**STRUCTURE** Legs in shaped wood  
**TOP** Marble or Laminam. Also available wood with shaped edge, veneered or lacquered  
**BASE** Plate base in wood veneered or lacquered. Ring in metal



TAVOLO | TABLE

**0571 BRAD**  
CM Ø 180 X 78 H  
**0571/S BRAD**  
CM Ø 160 X 78 H

**STRUTTURA** Gambe in legno sagomato  
**TOP** Marmo o Laminam. Disponibile anche in legno impiallacciato o laccato  
**BASE** Piatto in legno impiallacciato o laccato, anello in metallo

**STRUCTURE** legs in shaped wood  
**TOP** Marble or Laminam. Also available wood with shaped edge, veneered or lacquered  
**BASE** Plate base in wood veneered or lacquered. Ring in metal



TAVOLO | TABLE

**0574 FRAC**  
CM Ø 180 X 76 H  
**0574/S FRAC**  
CM Ø 160 X 76 H

**STRUTTURA** Legno laccato o impiallacciato sagomato e rivestito in pelle o tessuto  
**TOP** Marmo. Disponibile anche in legno impiallacciato o laccato con sottotop in legno

**STRUCTURE** Laquered or veneered shaped wood and covered in leather or fabric  
**TOP** Marble. Also available wood with shaped edge, veneered or lacquered with under wood top



TAVOLO | TABLE

**0575 FRAC**  
CM Ø 180 X 76,5 H  
**0575/S FRAC**  
CM Ø 160 X 76,5 H

**STRUTTURA** Legno laccato o impiallacciato sagomato e rivestito in pelle o tessuto  
**TOP** Laminam composto da 3 parti con sottotop in legno

**STRUCTURE** Laquered or veneered shaped wood and covered in leather or fabric  
**TOP** Laminam composed of 3 parts with under wood top



TAVOLO | TABLE

**0576/K TIGHT**  
CM 300 X 110 X 76 H  
**0576/N TIGHT**  
CM 250 X 110 X 76 H  
**0576 TIGHT**  
CM 220 X 110 X 76 H  
**0576/S TIGHT**  
CM 180 X 110 X 76 H

**STRUTTURA** Legno laccato o impiallacciato sagomato e rivestito in pelle o tessuto  
**TOP** Marmo o laminam. Disponibile anche in legno impiallacciato o laccato con sottotop in legno

**STRUCTURE** Laquered or veneered shaped wood and covered in leather or fabric  
**TOP** Marble or laminam. Also available wood with shaped edge, veneered or lacquered with under wood top





SEDIA | CHAIR

**0601 CAROL**

CM 59 X 60 X 93 H Con metallo | With metal

**0601/L CAROL**

CM 59 X 60 X 93 H Senza metallo | Without metal

**STRUTTURA / SEDUTA** Telaio in legno curvato, imbottitura con gomma a densità differenziate. Gambe in legno di faggio

**RIVESTIMENTO** Pelle o tessuto con cuciture

**BACKREST / SEAT** Curved wooden frame, padding with differentiated density rubber. Solid beech wood legs

**COVER** Leather and fabric with stitching



SEDIA | CHAIR

**0600 KALLY**

CM 52 X 62 X 86 H Con profilo | With profile

**0600/L KALLY**

CM 52 X 62 X 86 H Senza profilo | Without profile

**STRUTTURA / SEDUTA** Telaio in legno curvato, imbottitura con gomma a densità differenziate. Gambe in legno di faggio

**RIVESTIMENTO** Pelle o tessuto con cuciture

**BACKREST/SEAT** Curved wooden frame, padding with differentiated density rubber. Solid beech wood legs

**COVER** Leather and fabric with stitching



SEDIA | CHAIR

**0602 ALINA**

CM 67 X 58 X 84 H

**STRUTTURA / SEDUTA** Telaio in legno curvato, imbottitura con gomma a densità differenziate

**RIVESTIMENTO** Pelle e tessuto con cuciture

**BACKREST/SEAT** Curved wooden frame, padding with differentiated density rubber.

**COVER** Leather and fabric with stitching





LETTO | BED

**0800 PHILIPPE**

CM 217 X 220 X 132/30 H (RETE SPRING 180 X 200)

**0800/N PHILIPPE**

CM 197 X 210 X 132/30 H (RETE SPRING 160 X 190)

**0800/K PHILIPPE**

CM 237 X 220 X 132/30 H (RETE SPRING 200 X 200)

**0800/AQ PHILIPPE**

CM 190 X 223 X 132/30 H (RETE SPRING 153 X 203)

**0800/AK PHILIPPE**

CM 230 X 223 X 132/30 H (RETE SPRING 193 X 203)

**TESTIERA** Legno sagomato imbottito con gomme. Profilo in legno

**RING** Smontabile in pannelli di legno imbottiti, assemblati con elementi in metallo

**BASE** Legno rivestito con metallo

**RETE** Doghe in legno di faggio, predisposta per appoggio

**RIVESTIMENTO** Pelle o tessuto non removibile, retro in fodera

**HEADBOARD** Curved wood padded with rubber. Wood details

**RING** Detachable ring in wooden panels covered, fittings with metal brackets

**BASE** Wood with metal

**BEDBASE** Beech wooden slats ready to support

**COVER** Not removable cover in leather or fabric, back with lining



LETTO | BED

**0805 EUPHORIA**

CM 208 X 218 X 155/30 H (RETE SPRING 180 X 200)

**0805/N EUPHORIA**

CM 188 X 208 X 155/30 H (RETE SPRING 160 X 190)

**0805/K EUPHORIA**

CM 228 X 218 X 155/30 H (RETE SPRING 200 X 200)

**0805/AQ EUPHORIA**

CM 181 X 221 X 155/30 H (RETE SPRING 153 X 203)

**0805/AK EUPHORIA**

CM 221 X 221 X 155/30 H (RETE SPRING 193 X 203)

**TESTIERA** Legno rivestito con gomme. Dettagli in metallo

**RING** Smontabile in pannelli di legno imbottiti, assemblati con elementi in metallo

**RETE** Doghe in legno di faggio, predisposta per appoggio

**RIVESTIMENTO** Pelle o tessuto non removibile, retro in fodera

**HEADBOARD** Wood padded with rubber, Metal details

**RING** Detachable ring in wooden panels covered, fittings with metal brackets

**BEDBASE** Beech wooden slats ready to support

**COVER** Not removable cover in leather or fabric, back with lining

*Le guide e le cerniere sono con meccanismo soft. Soft closing for runners and hinges*



LETTO | BED

**0802 SUSAN**

CM 193 X 220 X 130/30 H (RETE SPRING 180 X 200)

**0802/N SUSAN**

CM 173 X 210 X 130/30 H (RETE SPRING 160 X 190)

**0802/K SUSAN**

CM 213 X 220 X 130/30 H (RETE SPRING 200 X 200)

**0802/AQ SUSAN**

CM 166 X 223 X 130/30 H (RETE SPRING 153 X 203)

**0802/AK SUSAN**

CM 206 X 223 X 130/30 H (RETE SPRING 193 X 203)

**TESTIERA** Legno imbottito con gomme

**RING** Smontabile in pannelli di legno imbottiti, assemblati con elementi in metallo

**BASE** Legno rivestito con metallo

**RETE** Doghe in legno di faggio, predisposta per appoggio

**RIVESTIMENTO** Pelle o tessuto non removibile, retro in fodera

**HEADBOARD** Wood padded with rubber

**RING** Detachable ring in wooden panels covered, fittings with metal brackets

**BASE** Wood with metal

**BEDBASE** Beech wooden slats ready to support

**COVER** Not removable cover in leather or fabric, back with lining



LETTO | BED

**0806 MASTER**

CM 198 X 218 X 113/30 H (RETE SPRING 180 X 200)

**0806/N MASTER**

CM 178 X 208 X 113/30 H (RETE SPRING 160 X 190)

**0806/K MASTER**

CM 218 X 218 X 113/30 H (RETE SPRING 200 X 200)

**0806/AQ MASTER**

CM 171 X 221 X 113/30 H (RETE SPRING 153 X 203)

**0806/AK MASTER**

CM 211 X 221 X 113/30 H (RETE SPRING 193 X 203)

**TESTIERA** Legno imbottito con gomme

**RING** Smontabile in pannelli di legno imbottiti, assemblati con elementi in metallo

**BASE** Legno rivestito in pelle o tessuto

**RETE** Doghe in legno di faggio, predisposta per appoggio

**RIVESTIMENTO** Pelle o tessuto non removibile, retro in fodera

**HEADBOARD** Wood padded with rubber

**RING** Detachable ring in wooden panels covered, fittings with metal brackets

**BASE** Wood covered with leather or fabric

**BEDBASE** Beech wooden slats ready to support

**COVER** Not removable cover in leather or fabric, back with lining



LETTO | BED

**0801 NORTON**

CM 348 X 220 X 130/30 H (RETE SPRING 180 X 200)

**0801/N NORTON**

CM 328 X 210 X 130/30 H (RETE SPRING 160 X 190)

**0801/K NORTON**

CM 368 X 220 X 130/30 H (RETE SPRING 200 X 200)

**0801/AQ NORTON**

CM 321 X 223 X 130/30 H (RETE SPRING 153 X 203)

**0801/AK NORTON**

CM 361 X 223 X 130/30 H (RETE SPRING 193 X 203)

**TESTIERA** Legno imbottito con gomme

**RING** Smontabile in pannelli di legno imbottiti, assemblati con elementi in metallo

**BASE** Legno rivestito con metallo

**RETE** Doghe in legno di faggio, predisposta per appoggio

**RIVESTIMENTO** Pelle o tessuto non removibile, retro in fodera

**HEADBOARD** Wood padded with rubber

**RING** Detachable ring in wooden panels covered, fittings with metal brackets

**BASE** Wood with metal

**BEDBASE** Beech wooden slats ready to support

**COVER** Not removable cover in leather or fabric, back with lining



LETTO | BED

**0807 PLUME**

CM 122 X 216 X 110/30 H (RETE)

**TESTIERA** Legno sagomato rivestito con gomme

**RING** Smontabile in pannelli di legno imbottiti, assemblati con elementi in metallo

**RETE** Legno

**RETE** Doghe in legno di faggio, predisposta per appoggio

**RIVESTIMENTO** Pelle o tessuto non removibile, retro in fodera

**HEADBOARD** Curved wood padded with rubber

**RING** Detachable ring in wooden panels covered, fittings with metal brackets

**BASE** Wood

**BEDBASE** Beech wooden slats ready to support

**COVER** Not removable cover in leather or fabric, back with lining



LETTO | BED

**0803 LOVE**

CM 206 X 222 X 125/30 H (RETE SPRING 180 X 200)

**0803/N LOVE**

CM 186 X 212 X 125/30 H (RETE SPRING 160 X 190)

**0803/K LOVE**

CM 226 X 222 X 125/30 H (RETE SPRING 200 X 200)

**0803/AQ LOVE**

CM 179 X 225 X 125/30 H (RETE SPRING 153 X 203)

**0803/AK LOVE**

CM 219 X 225 X 125/30 H (RETE SPRING 193 X 203)

**TESTIERA** Legno sagomato rivestito con gomme. Dettagli in metallo

**RING** Smontabile in pannelli di legno imbottiti, assemblati con elementi in metallo

**BASE** Legno

**RETE** Doghe in legno di faggio, predisposta per appoggio

**RIVESTIMENTO** Pelle o tessuto non removibile, retro in fodera

**HEADBOARD** Curved wood padded with rubber. Metal details

**RING** Detachable ring in wooden panels covered, fittings with metal brackets

**BASE** Wood

**BEDBASE** Beech wooden slats ready to support

**COVER** Not removable cover in leather or fabric, back with lining





COMODINO 1 CASSETTO | NIGHT TABLE 1 DRAWER

**0720 PAUL**  
CM 60 X 40 X 55 H

**TOP** Legno con bordo sagomato, impiallacciato o laccato, oppure in marmo. Dettagli in metallo. Sottotop in legno rivestito con pelle o tessuto  
**CASSETTI** Legno con frontali rivestiti in pelle o tessuto. Interno legno laccato e rivestito in microfibra, apertura con sistema push-pull  
**BASE** Legno sagomato

**TOP** Wood with shaped edge, veneered or lacquered. Also available with marble top. Metal detail. Curved under wood top covered with leather or fabric  
**DRAWERS** Frontal drawers wood covered in leather or fabric. Internal drawers in lacquered wood and with microfiber cover, push-pull opening system  
**BASE** Shaped wood



COMODINO 2 CASSETTI | NIGHT TABLE 2 DRAWERS

**0721 JULES**  
CM 60 X 40 X 55 H

**STRUTTURA** Legno curvato impiallacciato o laccato. Dettagli in metallo  
**TOP** Legno con bordo sagomato, impiallacciato o laccato, oppure in marmo. Sottotop in legno rivestito con pelle o tessuto  
**CASSETTI** Legno con frontali rivestiti in pelle o tessuto. Interno legno laccato e rivestito in microfibra, apertura con sistema push-pull  
**BASE** Legno sagomato  
**MANIGLIE** Acciaio

**STRUCTURE** Curved wood veneered or lacquered. Metal details  
**TOP** Wood with shaped edge, veneered or lacquered. Also available with marble top. Curved under wood top covered with leather or fabric  
**DRAWERS** Frontal drawers wood covered in leather or fabric. Internal drawers in lacquered wood and with microfiber cover, push-pull opening system  
**BASE** Shaped wood  
**HANDLES** Steel

*Le guide e le cerniere sono con meccanismo soft. Soft closing for runners and hinges*



COMÒ 3 CASSETTI | DRESSER 3 DRAWERS

**0701 LOUIS**  
CM 140 X 52 X 87 H

**STRUTTURA** Legno curvato impiallacciato o laccato. Dettagli in metallo  
**TOP** Legno con bordo sagomato, impiallacciato o laccato, oppure in marmo. Sottotop in legno rivestito con pelle o tessuto  
**CASSETTI** Legno con frontali rivestiti in pelle o tessuto. Interno legno laccato e rivestito in microfibra, apertura con sistema push-pull  
**BASE** Legno sagomato  
**MANIGLIE** Acciaio

**STRUCTURE** Curved wood veneered or lacquered. Metal details  
**TOP** Wood with shaped edge, veneered or lacquered. Also available with marble top. Curved under wood top covered with leather or fabric  
**DRAWERS** Frontal drawers wood covered in leather or fabric. Internal drawers in lacquered wood and with microfiber cover, push-pull opening system.  
**BASE** Shaped wood  
**HANDLES** Steel



COMÒ 6 CASSETTI | DRESSER 6 DRAWERS

**0702 PIERR**  
CM 170 X 52 X 87 H

**STRUTTURA** Legno curvato impiallacciato o laccato. Dettagli in metallo  
**TOP** Legno con bordo sagomato, impiallacciato o laccato, oppure in marmo. Sottotop in legno rivestito con pelle o tessuto  
**CASSETTI** Legno con frontali rivestiti in pelle o tessuto. Interno legno laccato e rivestito in microfibra, apertura con sistema push-pull  
**BASE** Legno sagomato  
**MANIGLIE** Acciaio

**STRUCTURE** Curved wood veneered or lacquered. Metal details  
**TOP** Wood with shaped edge, veneered or lacquered. Also available with marble top. Curved under wood top covered with leather or fabric  
**DRAWERS** Frontal drawers wood covered in leather or fabric. Internal drawers in lacquered wood and with microfiber cover, push-pull opening system  
**BASE** Shaped wood  
**HANDLES** Steel



COMÒ 6 CASSETTI | DRESSER 6 DRAWERS

**0703 MARCEL**  
CM 90 X 52 X 130 H

**STRUTTURA** Legno curvato impiallacciato o laccato. Dettagli in metallo  
**TOP** Legno con bordo sagomato, impiallacciato o laccato, oppure in marmo. Sottotop in legno rivestito con pelle o tessuto  
**CASSETTI** Legno con frontali rivestiti in pelle o tessuto. Interno legno laccato e rivestito in microfibra, apertura con sistema push-pull  
**BASE** Legno sagomato  
**MANIGLIE** Acciaio

**STRUCTURE** Curved wood veneered or lacquered. Metal details  
**TOP** Wood with shaped edge, veneered or lacquered. Also available with marble top. Curved under wood top covered with leather or fabric  
**DRAWERS** Frontal drawers wood covered in leather or fabric. Internal drawers in lacquered wood and with microfiber cover, push-pull opening system  
**BASE** Shaped wood  
**HANDLES** Steel



TOILETTE 2 CASSETTI | DRESSING TABLE 2 DRAWERS

**0700 PATTY**  
CM 140 X 52 X 78 H

**TOP** Legno con bordo sagomato, impiallacciato o laccato. Piano con specchio apribile a ribalta e vano portaoggetti. Dettagli in metallo. Sottotop in legno rivestito con pelle o tessuto  
**CASSETTI** Legno con frontali rivestiti in pelle o tessuto. Interno legno laccato e rivestito in microfibra, apertura con sistema push-pull  
**BASE** Legno sagomato

**TOP** Wood with shaped edge, veneered or lacquered and with folding opening and storage compartment. Metal detail. Curved under wood top covered with leather or fabric  
**DRAWERS** Frontal drawers wood covered in leather or fabric. Internal drawers in lacquered wood and with microfiber cover, push-pull opening system  
**BASE** Shaped wood



CASSETTIERA A ISOLA | ISLAND CHEST OF DRAWERS

**0711 BLOOM**  
CM 240 X 90 X 71 H

**STRUTTURA** Legno curvato impiallacciato o laccato con inserti in pelle o tessuto. Dettagli in metallo. Fianco laterale apribile  
**TOP** Vetro  
**CASSETTI** Legno impiallacciato o laccato con frontali in vetro. Interno legno laccato e rivestito in microfibra, apertura con sistema push-pull  
**BASE** Metallo

**STRUCTURE** Curved wood veneered or lacquered with leather or fabric insert. Metal details. Side panel that can be opened  
**TOP** Glass  
**DRAWERS** Veneered or lacquered wood with glass frontal drawers. Internal drawers in lacquered wood and with microfiber cover, push-pull opening system  
**BASE** Metal



POUFF | POUFFE

**0850 MORGAN**  
CM 45 X 45 X 40 H

**STRUTTURA / SEDUTA** Telaio in legno con imbottitura in poliuretano espanso a densità differenziate  
**RIVESTIMENTO** Tessuto o pelle  
**BASAMENTO** In legno con profilo in metallo

**STRUCTURE / SEAT** Wooden frame with differentiated density polyurethane foam padding  
**COVER** Fabric or leather  
**BASE** Wooden base with metal profile





COMODINO 2 CASSETTI | NIGHT TABLE 2 DRAWERS

**0724 WISH**  
CM 60 X 40 X 55 H

**STRUTTURA/TOP** Legno impiallacciato o laccato. Dettagli in metallo  
**CASSETTI** Legno con frontali disegno cannettè. Interno legno laccato e rivestito in microfibra

**STRUCTURE / TOP** Wood veneered or lacquered. Metal details  
**DRAWERS** Frontal drawers cannettè. Internal drawers in lacquered wood and with microfiber cover



COMO 3 CASSETTI | DRESSER 3 DRAWERS

**0708 TOUCH**  
CM 136 X 50 X 80 H

**STRUTTURA/TOP** Legno impiallacciato o laccato. Dettagli in metallo  
**CASSETTI** Legno con frontali laccati con disegno cannettè. Interno legno laccato e rivestito in microfibra

**STRUCTURE / TOP** Wood veneered or lacquered. Metal details  
**DRAWERS** Wood with lacquered frontal drawers with cannettè design. Internal drawers in lacquered wood and with microfiber cover



COMODINO 2 CASSETTI | NIGHT TABLE 2 DRAWERS

**0722 FLUTE**  
CM 68 X 43 X 50 H

**STRUTTURA** Legno curvato impiallacciato o laccato. Dettagli metallo  
**TOP** Marmo o laminam. Disponibile anche in legno impiallacciato o laccato  
**CASSETTI** Legno impiallacciato o laccato. Interno legno laccato e rivestito in microfibra, apertura con sistema push-pull  
**BASE** Legno

**STRUCTURE** Curved wood veneered or lacquered. Metal details  
**TOP** Marble or laminam. Also available with wood veneered or lacquered  
**DRAWERS** Frontal drawers wood veneered or lacquered. Internal drawers in lacquered wood and with microfiber cover, push-pull opening system  
**BASE** Solid wood



COMÒ 3 CASSETTI | DRESSER 3 DRAWERS

**0704 FLORIS**  
CM 150 X 55 X 80 H

**STRUTTURA** Legno curvato impiallacciato o laccato. Dettagli metallo  
**TOP** Marmo o laminam. Disponibile anche in legno impiallacciato o laccato  
**CASSETTI** Legno impiallacciato o laccato. Interno legno laccato e rivestito in microfibra, apertura con sistema push-pull  
**BASE** Legno

**STRUCTURE** Curved wood veneered or lacquered. Metal details  
**TOP** Marble or laminam. Also available with wood veneered or lacquered  
**DRAWERS** Frontal drawers wood veneered or lacquered. Internal drawers in lacquered wood and with microfiber cover, push-pull opening system  
**BASE** Solid wood



SCRIVANIA | DESK

**0709 SCREEN**  
CM 136 X 50 X 76 H

**STRUTTURA/TOP** Legno impiallacciato o laccato. Dettagli in metallo  
**CASSETTI** Legno con frontali laccati con disegno cannettè. Interno legno laccato e rivestito in microfibra

**STRUCTURE / TOP** Wood veneered or lacquered. Metal details  
**DRAWERS** Wood with lacquered frontal drawers with cannettè design. Internal drawers in lacquered wood and with microfiber cover



ARMADIO 3 ANTE | WARDROBE 3 DOORS

**0750 HONEY**  
CM 196 X 60 X 232 H

**STRUTTURA** Legno impiallacciato o laccato  
**ANTE** Legno impiallacciato o laccato con inserti in pelle o tessuto

**STRUCTURE** Veneered or lacquered wood  
**TOP** Veneered or lacquered wood with leather or fabric insert



COMÒ 6 CASSETTI | DRESSER 6 DRAWERS

**0705 TURNER**  
CM 180 X 55 X 80 H

**STRUTTURA** Legno curvato impiallacciato o laccato. Dettagli metallo  
**TOP** Marmo o laminam. Disponibile anche in legno impiallacciato o laccato  
**CASSETTI** Legno impiallacciato o laccato. Interno legno laccato e rivestito in microfibra, apertura con sistema push-pull  
**BASE** Legno

**STRUCTURE** Curved wood veneered or lacquered. Metal details  
**TOP** Marble or laminam. Also available with wood veneered or lacquered  
**DRAWERS** Frontal drawers wood veneered or lacquered. Internal drawers in lacquered wood and with microfiber cover, push-pull opening system  
**BASE** Solid wood

*Le guide e le cerniere sono con meccanismo soft. Soft closing for runners and hinges*





COMODINO 2 CASSETTI | NIGHT TABLE 2 DRAWERS

**0723 SKIN**  
CM 60 X 40 X 55 H

**STRUTTURA / TOP** Legno impiallacciato o laccato. Dettagli in metallo  
**CASSETTI** Legno con frontali rivestiti in pelle o tessuto. Interno legno laccato e rivestito in microfibra. Dettagli in metallo

**STRUCTURE / TOP** Wood veneered or lacquered. Metal details  
**DRAWERS** Frontal drawers wood covered in leather or fabric. Internal drawers in lacquered wood and with microfiber cover. Metal details



COMODINO 2 CASSETTI | NIGHT TABLE 2 DRAWERS

**0725 TAYLOR**  
CM 63 X 43 X 54 H

**STRUTTURA/TOP** Legno curvato impiallacciato o laccato. Dettagli in pelle o tessuto  
**CASSETTI** Legno impiallacciato o laccato con dettagli in pelle o tessuto. Interno legno laccato e rivestito in microfibra, apertura con sistema push-pull

**STRUCTURE** Curved wood veneered or lacquered. Leather of fabric details  
**DRAWERS** Frontal drawers wood veneered or lacquered with leather or fabric details. Internal drawers in lacquered wood and with microfiber cover, push-pull opening system



COMO 3 CASSETTI | DRESSER 3 DRAWERS

**0712 SWING**  
CM 136 X 50 X 84 H

**STRUTTURA/TOP** Legno curvato impiallacciato o laccato. Dettagli in pelle o tessuto  
**CASSETTI** Legno impiallacciato o laccato con dettagli in pelle o tessuto. Interno legno laccato e rivestito in microfibra, apertura con sistema push-pull

**STRUCTURE** Curved wood veneered or lacquered. Leather of fabric details  
**DRAWERS** Frontal drawers wood veneered or lacquered with leather or fabric details. Internal drawers in lacquered wood and with microfiber cover, push-pull opening system



COMO 6 CASSETTI | DRESSER 6 DRAWERS

**0710 GLOVE**  
CM 160 X 50 X 84 H

**STRUTTURA/TOP** Legno curvato impiallacciato o laccato. Dettagli in pelle o tessuto  
**CASSETTI** Legno impiallacciato o laccato con dettagli in pelle o tessuto. Interno legno laccato e rivestito in microfibra, apertura con sistema push-pull

**STRUCTURE** Curved wood veneered or lacquered. Leather of fabric details  
**DRAWERS** Frontal drawers wood veneered or lacquered with leather or fabric details. Internal drawers in lacquered wood and with microfiber cover, push-pull opening system



COMÒ 3 CASSETTI | DRESSER 3 DRAWERS

**0706 CREED**  
CM 136 X 50 X 80 H

**STRUTTURA / TOP** Legno impiallacciato o laccato. Dettagli in metallo  
**CASSETTI** Legno con frontali rivestiti in pelle o tessuto. Interno legno laccato e rivestito in microfibra. Dettagli in metallo

**STRUCTURE / TOP** Wood veneered or lacquered. Metal details  
**DRAWERS** Frontal drawers wood covered in leather or fabric. Internal drawers in lacquered wood and with microfiber cover. Metal details



COMO 6 CASSETTI | DRESSER 6 DRAWERS

**0707 CLIPPER**  
CM 170 X 50 X 80 H

**STRUTTURA / TOP** Legno impiallacciato o laccato. Dettagli in metallo  
**CASSETTI** Legno con frontali rivestiti in pelle o tessuto. Interno legno laccato e rivestito in microfibra. Dettagli in metallo

**STRUCTURE / TOP** Wood veneered or lacquered. Metal details  
**DRAWERS** Frontal drawers wood covered in leather or fabric. Internal drawers in lacquered wood and with microfiber cover. Metal details



PANCHETTA | BENCH

**0851 MIRIAN**  
CM 130 X 50 X 40 H

**STRUTTURA / SEDUTA** Telaio in legno con imbottitura in poliuretano espanso a densità differenziate  
**RIVESTIMENTO** Tessuto o pelle  
**BASAMENTO** In legno con profilo in metallo

**STRUCTURE / SEAT** Wooden frame with differentiated density polyurethane foam padding  
**COVER** Fabric or leather  
**BASE** Wooden base with metal profile



POLTRONCINA | ARMCHAIR

**0852 THEA**  
CM 83,5 X 90 X 83 H

**STRUTTURA / SEDUTA** Telaio in legno con imbottitura in poliuretano espanso a densità differenziate. Seduta con cinghie elastiche  
**CUSCINATURA** Gomma con strato superiore in memory  
**RIVESTIMENTO** Tessuto o pelle. Rivestimento su scocca con trapuntatura  
**BASAMENTO** In legno rivestito in metallo

**STRUCTURE/SEAT** Wooden frame with differentiated density polyurethane foam padding. Seat with interwoven elastic bealt  
**CUSHIONS SEAT** Rubber with upper layer in memory foam  
**COVER** Fabric or leather. Quilted upholstery on the external structure  
**BASE** Wooden base covered in metal

Le guide e le cerniere sono con meccanismo soft. Soft closing for runners and hinges





SPECCHIO | MIRROR  
**0630 AUDRIN**  
CM Ø 100 H

**STRUTTURA** Pannello legno con specchio naturale  
**STRUCTURE** Wood panel with natural mirror



SPECCHIO | MIRROR  
**0632 LUX**  
CM 150 X 100 H

**STRUTTURA** Pannello legno rivestito in pelle o tessuto con specchio naturale  
**STRUCTURE** Wood panel covered in leather or fabric with natural mirror



SPECCHIO | MIRROR  
**0634 KATE**  
CM 40 X 80 H

**STRUTTURA** Pannello legno con specchio naturale  
**STRUCTURE** Wood panel with natural mirror



SPECCHIO | MIRROR  
**0636 LOOK**  
CM Ø 110 H

**STRUTTURA** Specchio naturale molato e inciso  
**STRUCTURE** Natural mirror ground and engraving



SPECCHIO | MIRROR  
**0631 GRACE**  
CM 100 X 100 H

**STRUTTURA** Pannello legno rivestito in pelle o tessuto con specchio naturale  
**STRUCTURE** Wood panel covered in leather or fabric with natural mirror



SPECCHIO | MIRROR  
**0633 SUZY**  
CM 50 X 50 H

**STRUTTURA** Pannello legno con specchio naturale  
**STRUCTURE** Wood panel with natural mirror



SPECCHIO | MIRROR  
**0635 LOLA**  
CM 40 X 40 H

**STRUTTURA** Pannello legno con specchio naturale  
**STRUCTURE** Wood panel with natural mirror





PIANTANA | FLOOR LAMP  
**0684 LONELY**  
 CM 50 X 28 X 157 H

LAMPADA DA TAVOLO | TABLE LAMP  
**0685 LONELY**  
 CM 42 X 22 X 66 H



LAMPADARIO 6 LUCI | 6 LIGHTS CHANDELIER  
**0670 WAVE**  
 CM Ø 74 X 66 H

LAMPADARIO | CHANDELIER  
**0671 WAVE**  
 CM Ø 48 X 54 H



PIANTANA | FLOOR LAMP  
**0672 WAVE**  
 CM Ø 39 X 171 H

LAMPADA DA TAVOLO | TABLE LAMP  
**0673 WAVE**  
 CM Ø 26 X 65 H

ABAT JOUR | NIGHT LAMP  
**0674 WAVE**  
 CM Ø 18 X 50 H

APPLIQUE | WALL LAMP  
**0675 WAVE**  
 CM 18 X 27 X 48 H



PIANTANA | FLOOR LAMP  
**0676 WAVE**  
 CM 50 X 28 X 157 H

LAMPADA DA TAVOLO | TABLE LAMP  
**0677 WAVE**  
 CM 42 X 22 X 66 H

ABAT JOUR | NIGHT LAMP  
**0678 WAVE**  
 CM 24 X 14 X 44 H

APPLIQUE | WALL LAMP  
**0679 WAVE**  
 CM 24 X 25 X 42 H

STRUTTURA Ottone  
 DETTAGLI Cristallo nero o trasparente, paralume in tessuto  
 ELETTTRIFICAZIONE Materiali norma CEE

STRUCTURE Brass with polished bright gold finishing  
 DETAILS Crystal black or transparent, lampshade in fabric  
 ELECTRIFICATION Standard EEC materials



PIANTANA | FLOOR LAMP  
**0680 WAVE**  
 CM Ø 48 X 150 H

LAMPADA DA TAVOLO | TABLE LAMP  
**0681 WAVE**  
 CM Ø 48 X 71 H

ABAT JOUR | NIGHT LAMP  
**0682 WAVE**  
 CM Ø 26 X 40 H

APPLIQUE | WALL LAMP  
**0683 WAVE**  
 CM Ø 26 X 38 H





CUSCINO | CUSCHION

**0360 TEAL**  
cm 55 X 45  
cm 42 X 42  
cm 38 X 38  
cm 35 X 35

**RIVESTIMENTO** Interno con piumino e gomma, rivestito con pelle o tessuto  
**OPTIONAL** Logo ricamato

**COVER** Goose down stuffing and rubber, padded with leather or fabric  
**OPTIONAL** Embroidered logo



CUSCINO | CUSCHION

**0362 TIA**  
cm 55 X 45  
cm 42 X 42  
cm 38 X 38  
cm 35 X 35

**RIVESTIMENTO** Interno con piumino e gomma, rivestito con pelle o tessuto  
**OPTIONAL** Logo ricamato

**COVER** Goose down stuffing and rubber, padded with leather or fabric  
**OPTIONAL** Embroidered logo



CUSCINO | CUSCHION

**0364 TEDDY**  
cm 55 X 45  
cm 42 X 42  
cm 38 X 38  
cm 35 X 35

**RIVESTIMENTO** Interno con piumino e gomma, rivestito con pelle o tessuto  
**OPTIONAL** Logo ricamato

**COVER** Goose down stuffing and rubber, padded with leather or fabric  
**OPTIONAL** Embroidered logo



CUSCINO | CUSCHION

**0361 TWILA**  
cm 55 X 45  
cm 42 X 42  
cm 38 X 38  
cm 35 X 35

**RIVESTIMENTO** Interno con piumino e gomma, rivestito con pelle o tessuto  
**OPTIONAL** Logo ricamato

**COVER** Goose down stuffing and rubber, padded with leather or fabric  
**OPTIONAL** Embroidered logo



CUSCINO | CUSCHION

**0363 TIAGO**  
cm 55 X 45  
cm 42 X 42  
cm 38 X 38  
cm 35 X 35

**RIVESTIMENTO** Interno con piumino e gomma, rivestito con pelle o tessuto  
**OPTIONAL** Logo ricamato

**COVER** Goose down stuffing and rubber, padded with leather or fabric  
**OPTIONAL** Embroidered logo



TAPPETO | CARPET

**0350 ROYAL**  
cm 300 X 200  
cm 400 X 400

**Disponibili al mq**  
Available measures per square meter

**Aspetto velluto / Composizione** 100% PA / **Costruzione** Tufting / **Sottofondo** juta / **Peso totale** 2500 g / mq / **Spessore** 10 mm optional logo

**Aspect Cut Pile / Composition** 100% PA / **Construction** Tufting / **Backing** Juta / **Total Weight** 2500 gr / mq / **Total Thickness** 10 mm optional logo



TAPPETO | CARPET

**0352 ROUND**  
cm Ø 350

**Disponibili al mq**  
Available measures per square meter

**Aspetto velluto / Composizione** 100% PA / **Costruzione** Tufting / **Sottofondo** juta / **Peso totale** 2500 g/mq / **Spessore** 10 mm optional logo

**Aspect Cut Pile / Composition** 100% PA / **Construction** Tufting / **Backing** Juta / **Total Weight** 2500gr / mq / **Total Thickness** 10 mm optional logo



TAPPETO | CARPET

**0354 SLOANE**  
cm Ø 350

**Disponibili al mq**  
Available measures per square meter

**Aspetto velluto / Composizione** 100% PA / **Costruzione** Tufting / **Sottofondo** juta / **Peso totale** 2500 g / mq / **Spessore** 10 mm optional logo

**Aspect Cut Pile / Composition** 100% PA / **Construction** Tufting / **Backing** Juta / **Total Weight** 2500 gr / mq / **Total Thickness** 10 mm optional logo



TAPPETO | CARPET

**0351 RIA**  
cm 300 X 200  
cm 400 X 400

**Disponibili al mq**  
Available measures per square meter

**Aspetto velluto / Composizione** 100% PA / **Costruzione** Tufting / **Sottofondo** juta / **Peso totale** 2500 g / mq / **Spessore** 10 mm optional logo

**Aspect Cut Pile / Composition** 100% PA / **Construction** Tufting / **Backing** Juta / **Total Weight** 2500 gr / mq / **Total Thickness** 10 mm optional logo



TAPPETO | CARPET

**0353 SOFT**  
cm 300 X 200  
cm 400 X 400

**Disponibili al mq**  
Available measures per square meter

**Aspetto velluto / Composizione** 100% PA / **Costruzione** Tufting / **Sottofondo** juta / **Peso totale** 2500 g / mq / **Spessore** 10 mm optional logo

**Aspect Cut Pile / Composition** 100% PA / **Construction** Tufting / **Backing** Juta / **Total Weight** 2500 gr / mq / **Total Thickness** 10 mm optional logo



SAMPLES

DISAPPEAR



**PELLE NABUK VOGUE COLLECTION CAT. A**  
LEATHER NABUK VOGUE COLLECTION CAT. A

Pelle bovina Nabuk pura aniline con grana naturale, di provenienza europea.  
Superficie media +5.0 m<sup>2</sup>. Spessore 1,2-1,4 mm. Concia al cromo. Tintura in botte con olii e grassi di elevata qualità.  
Articolo dall'aspetto scrivente e dalla mano morbida e vellutata.  
Eventuali piccole imperfezioni, testimoniano l'autenticità e la naturalità della pelle pura anilina.

Bovine of European origin in Nabuk finishing, natural grain.  
The average size of each skin is around 5.0 m<sup>2</sup>. Chrome tannage. Aniline dyed, finished with high quality oils. Suede look, soft and velvet touch.  
The possible presence of any imperfections testify the authenticity and the natural look of pure aniline leather

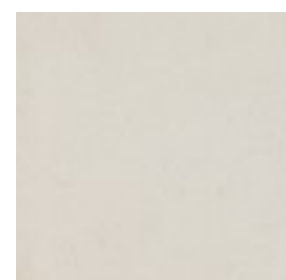

01015

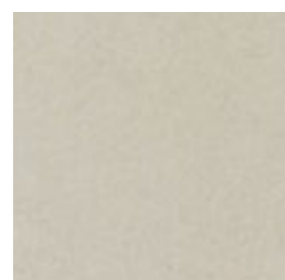

0854

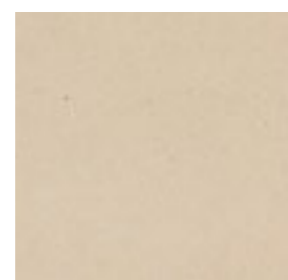

0197

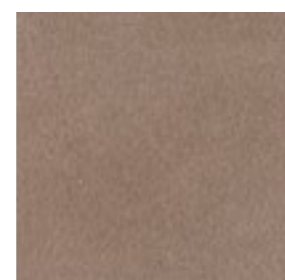

06048

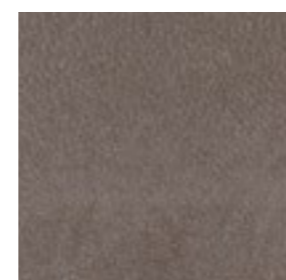

FUMO

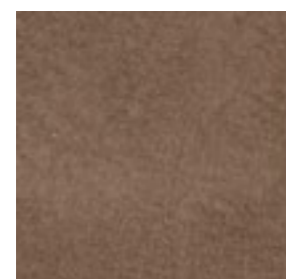

2116

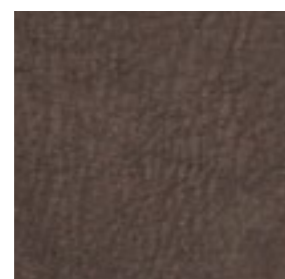

TESTA DI MORO

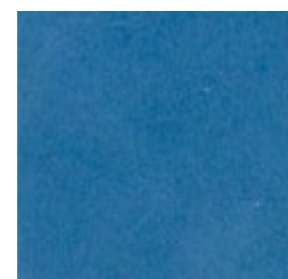

779



0855

**PELLE ZENIT COLLECTION CAT. B**  
LEATHER ZENIT COLLECTION CAT. B

Pelle bovina fiore a grana naturale di spessore finite 1,1mm.  
Superficie media 4,8-5,0 m<sup>2</sup>. Concia al cromo.  
Tintura anilina passante articolo con mano morbida, tatto ceroso e aspetto semiopaco.

Bovine of European origin, lightly buffed natural grain, finished thickness 1,1mm.  
The average size of each hide is around 4,8-5,0 sqm. Chrome tannage.  
Through aniline dyed article with a pigmented and protective coat, with a soft, waxy feel and semi-matt appearance.

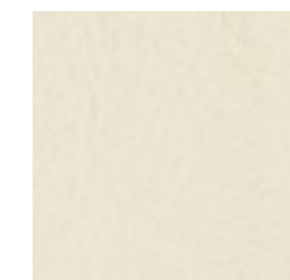

634

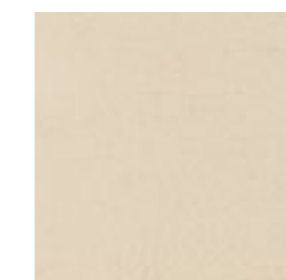

666

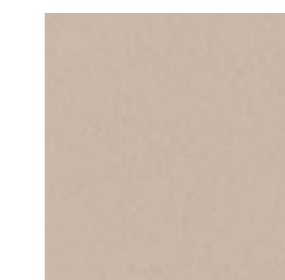

663

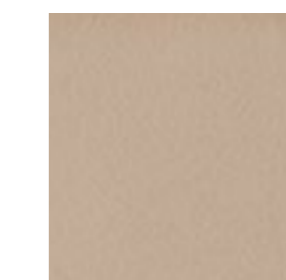

665

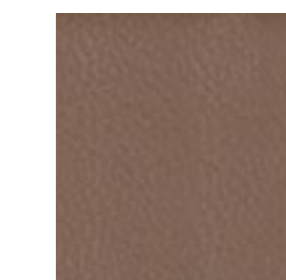

627

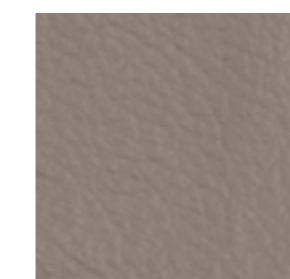

660

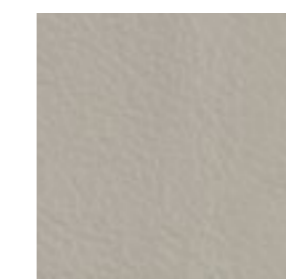

668

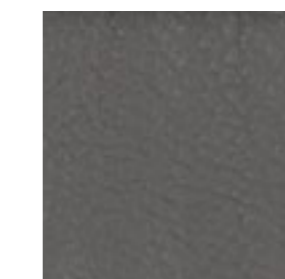

623

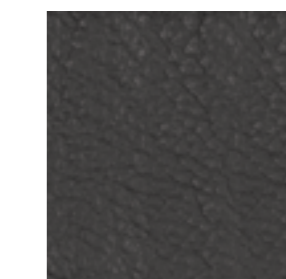

622

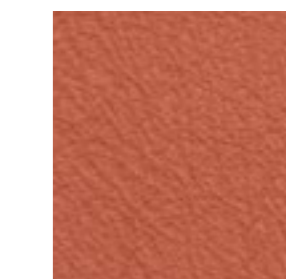

616



**TESSUTO ZEUS COLLECTION CAT. C**  
**FABRIC ZEUS COLLECTION CAT. C**

Altezza cm 138/140  
 Width cm 138/140  
 Peso gr/ml 680  
 Weight gr/ml 680

**Composizione**  
 Composition  
 44% VI  
 28% CO  
 15% LI  
 13% PL



01



02

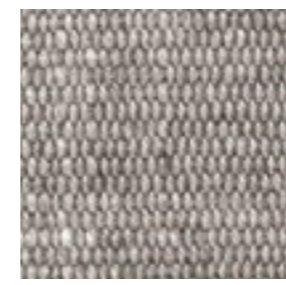

04



05



06



07

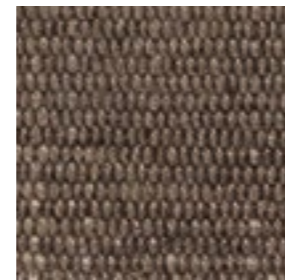

10



25

**TESSUTO LAMBERT COLLECTION CAT. C**  
**FABRIC LAMBERT COLLECTION CAT. C**

Altezza cm 138/140  
 Width cm 138/140  
 Peso gr/ml 600  
 Weight gr/ml 600

**Composizione**  
 Composition  
 68% PC  
 28% PL  
 4% VI



710



720



703



711

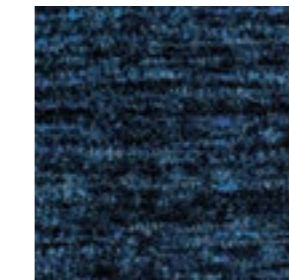

707



719

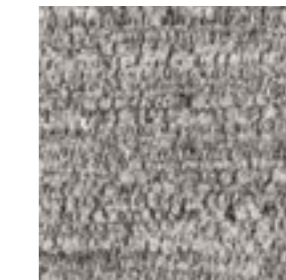

704



716

**TESSUTO BELLINI COLLECTION CAT. C**  
**FABRIC BELLINI COLLECTION CAT. C**

Altezza cm 140  
 Width cm 140  
 Peso gr/ml 800  
 Weight gr/ml 800

**Composizione**  
 Composition  
 71% VI  
 8% CO  
 14% LI  
 7% PL

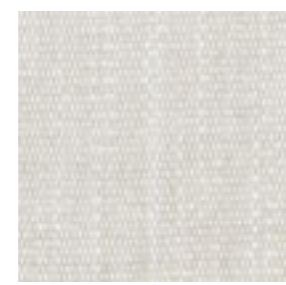

113



126



127

Lavorazione cannettè disponibile a richiesta. Cannettè processing available.



**VELLUTO DENIM COLLECTION CAT. C**  
VELVET DENIM COLLECTION CAT. C

Altezza cm 140  
Width cm 140  
Peso gr/ml 430  
Weight gr/ml 430  
Composizione  
Composition  
100% PL



H23

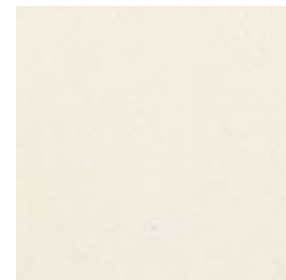

01

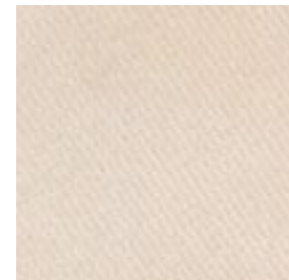

02

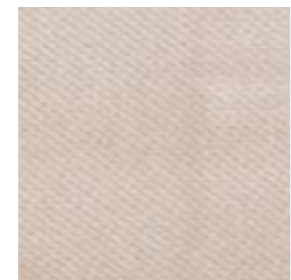

04

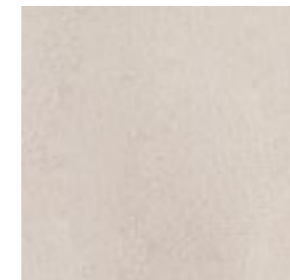

H20

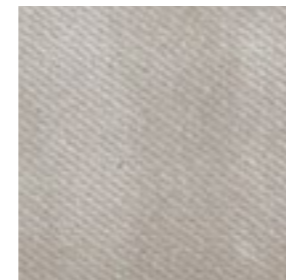

08

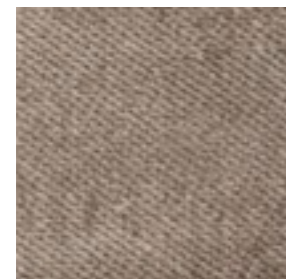

19

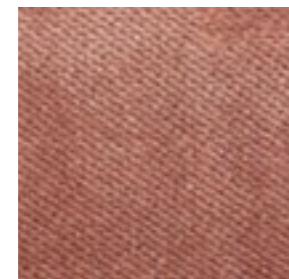

30

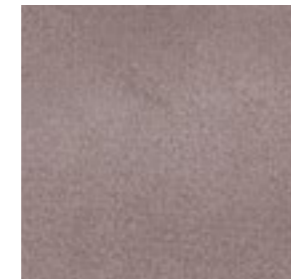

H130



H622

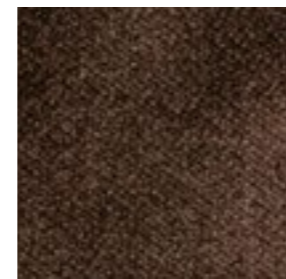

123

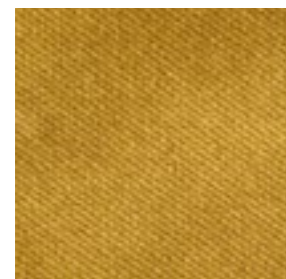

35

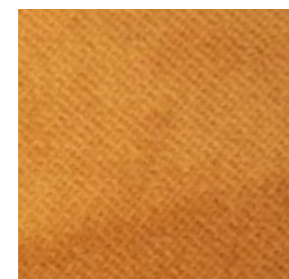

36



15

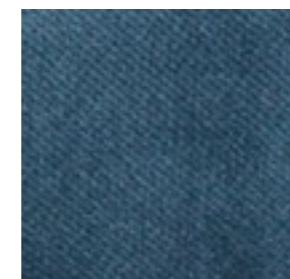

10

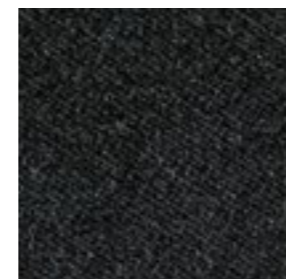

39

**VELLUTO VALERYE COLLECTION CAT. C**  
VELVET VALERYE COLLECTION CAT. C

Altezza cm 140  
Width cm 140  
Peso gr/ml 700  
Weight gr/ml 700  
Composizione  
Composition  
100% COTTON



V330



V336

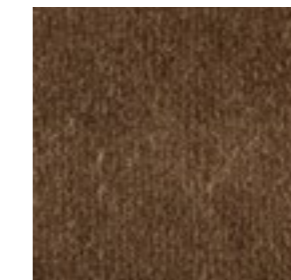

V339



ECO LEATHER OSCAR COLLECTION CAT. C

Altezza cm 140  
Width cm 140  
Peso gr/ml 550  
Weight gr/ml 550  
Composizione  
Composition  
85% PVC  
15%PL



25

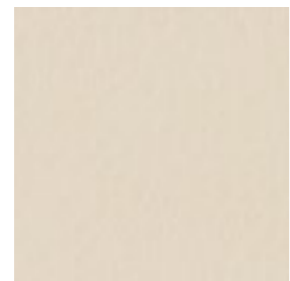

9

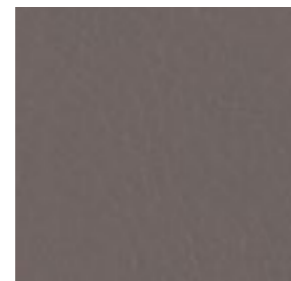

15

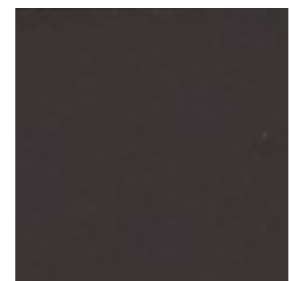

16

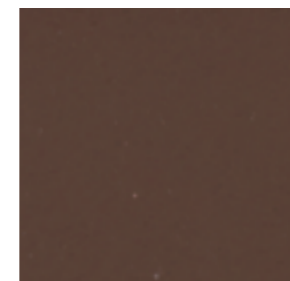

31



4



7

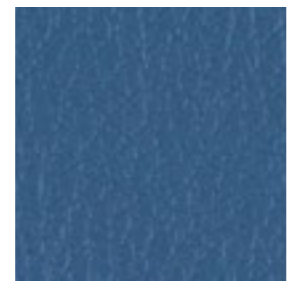

54

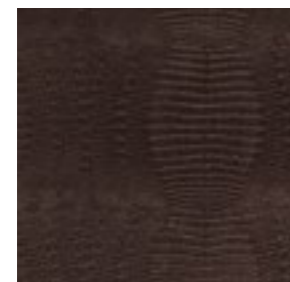

COCCODRILLO

TECNO NABUK REGENCY COLLECTION CAT. C

Altezza cm 140  
Width cm 140  
Peso gr/ml 730  
Weight gr/ml 730  
Composizione  
Composition  
100%PL

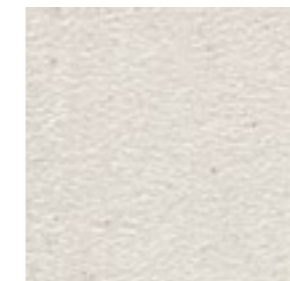

45

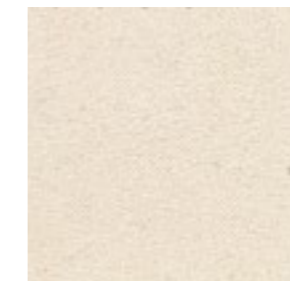

301



5



15

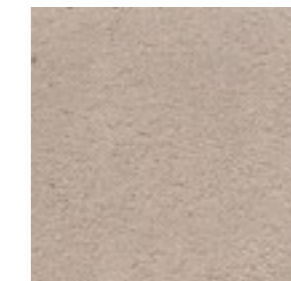

66

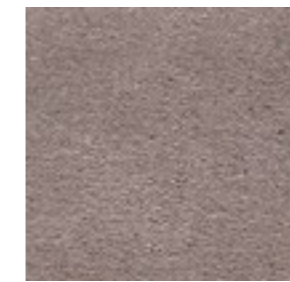

35



12



14



44



57



## LEGNO WOOD

I legni usati sono stagionati ed essiccati naturalmente. L'azienda utilizza legno laccato o impiallacciato ebano, palissandro dark o eucalipto grigio con finitura lucida o finitura opaca.

We use superior naturally seasoned and dried woods. The company propose lacquered wood or veneered in ebony, rosewood dark or eucalyptus gray with glossy brushed finishing. Alternative version in matt finishing.

### FINITURA ESSENZE LUCIDE O OPACHE | WOOD FINISHES GLOSSY OR MATT CAT. A

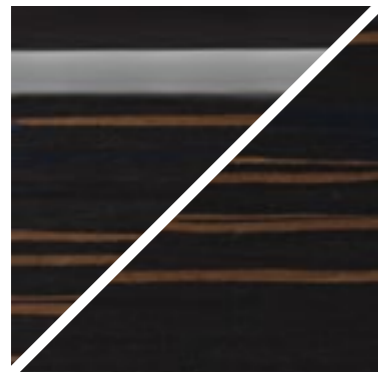

EBONY

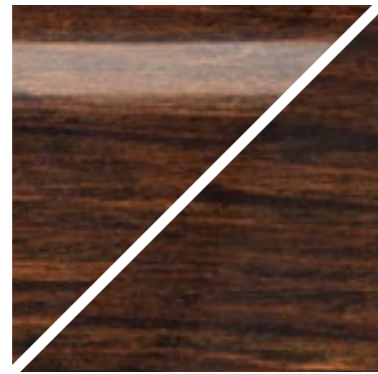

ROSEWOOD

### FINITURA ESSENZE OPACHE | WOOD FINISHES MATT CAT. B

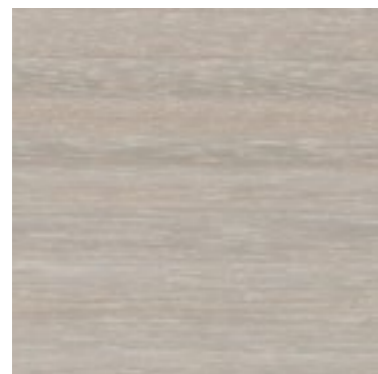

EUCALYPTUS GRAY



SICOMORO



OAK

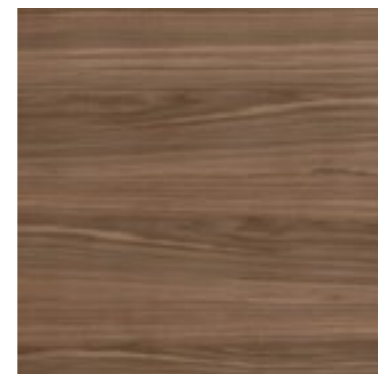

WALNUT

### FINITURA LACCATI LUCIDI O OPACHI | LACQUERED FINISHES GLOSSY OR MATT CAT. A



GLACIAL



CRETA



SHADE



MOKA



AVORIO



WHITE



BLACK



## MARMI MARBLES

I marmi utilizzati provengono da cave italiane.

All marbles we use come from italia marble quarries.



EMPERADOR DARK



CARRARA WHITE



CALACATTA



GIOIA WHITE

## LAMINAM LAMINAM

La lastra in gres porcellanato Laminam unisce allo spessore ridotto e alle grandi dimensioni un'elevata resistenza alle sollecitazioni meccaniche, ai prodotti chimici, all'usura, ai graffi, all'abrasione profonda e alla flessione; è facilmente igienizzabile, resistente al gelo, al fuoco, alle muffe, all'azione dei raggi UV. Tutte le caratteristiche e le proprietà cromatiche delle lastre sono inalterabili, restano immutate nel tempo e in presenza di ogni condizione atmosferica.

The Laminam porcelain stoneware slab combines reduced thickness and large dimensions with high resistance to mechanical stress, chemicals, wear, scratches, deep abrasion and bending; it is easily sanitized, resistant to frost, fire, mold and UV rays. All the characteristics and chromatic properties of the slabs are unalterable, they remain unchanged over time and in the presence of all weather conditions.

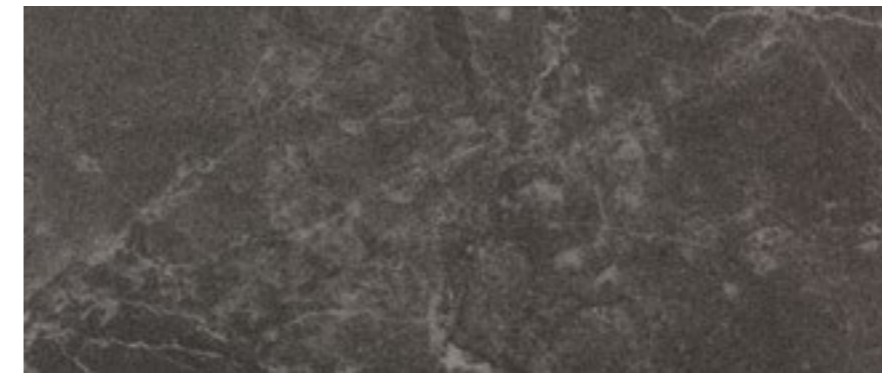

NERO GRECO



PIETRA DI SAVOIA

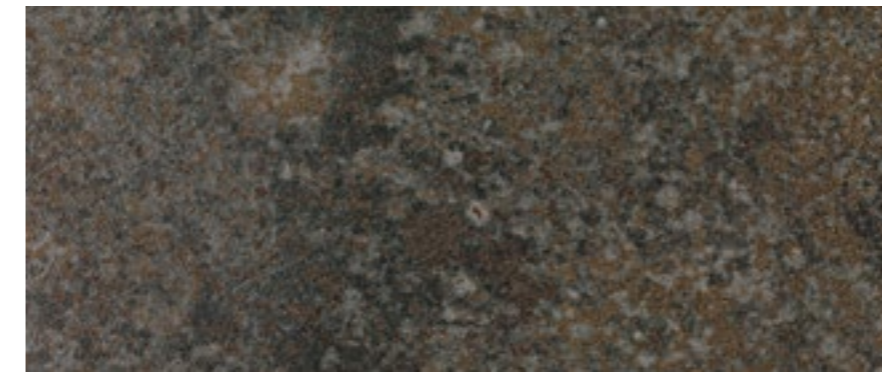

OSSIDO NERO

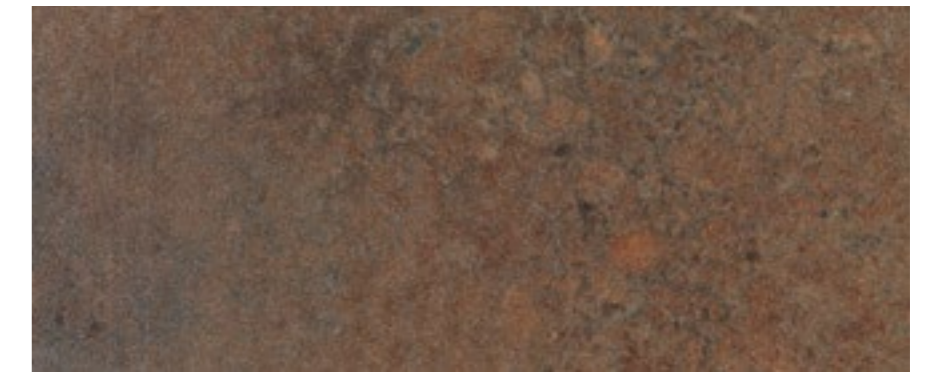

OSSIDO BRUNO



## FINITURE METALLI METAL FINISHES

Le parti metalliche sono con finiture ottone lucido, champagne satinato, rosa satinato o titanio.

All metal parts are made with polished bright gold, champagne gold, rose gold or titanium finishing.



GOLD

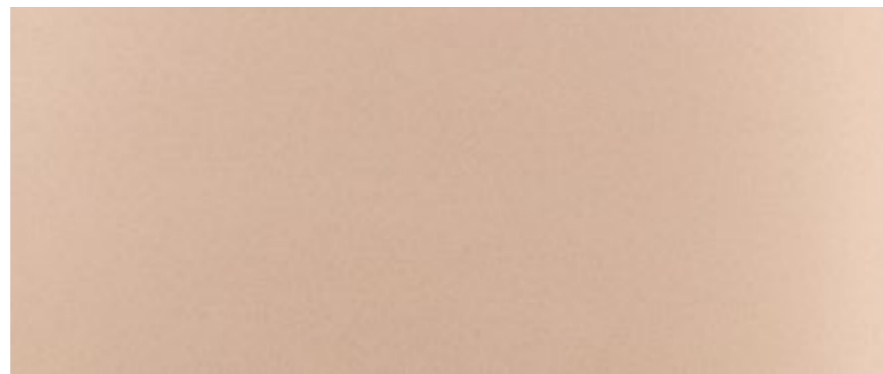

ROSE

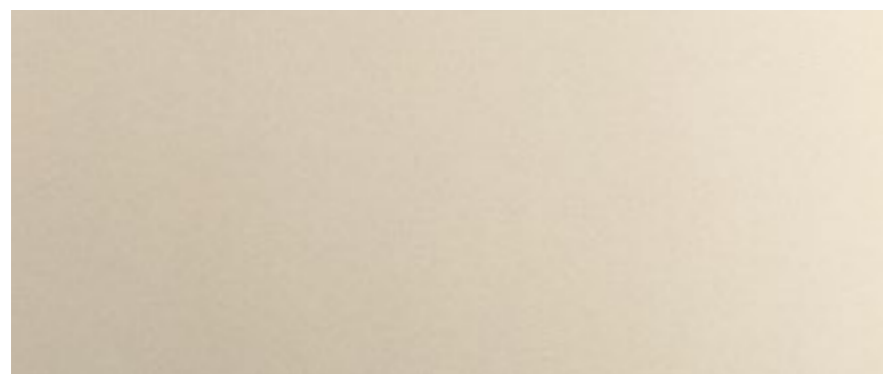

CHAMPAGNE

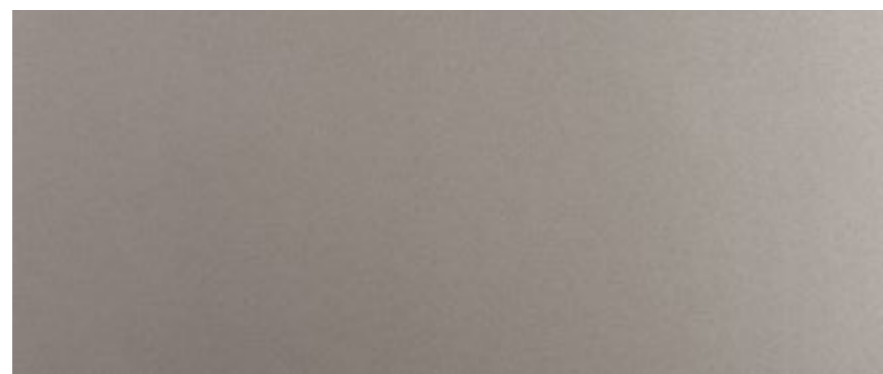

TITANIO









# ANTONELLI

## ATELIER

produced by

**ANTONELLI M. & C.SRL**  
56025 Pontedera (Pi) Italy  
Viale Africa, 24  
Tel. 0587 294260  
Fax 0587 294268  
mail [info@antonellimobili.it](mailto:info@antonellimobili.it)  
[www.antonelliatelier.it](http://www.antonelliatelier.it)

member of  
**GRUPPO**  
**CGIMO**

Designer | Silvano Del Guerra  
Padded project collaborator | Alessandro Sezzi  
Art direction and graphic design | faserem Santo Pietro Belvedere PI  
Art project and images | faserem Santo Pietro Belvedere PI  
Print | Ciani Artigrafiche Colle Val d'Elsa PI

Antonelli Atelier si riserva il diritto di apportare, senza preavviso, ogni modifica mirata al miglioramento funzionale e qualitativo dei propri prodotti. Testi e immagini presenti in questo catalogo hanno scopo divulgativo e per ogni aspetto tecnico e dimensioni fare riferimento al listino. I campioni colore, pelli e tessuti hanno valore indicativo.

Antonelli Atelier reserves the rights all time to apply modifications for the functional or qualitative improvement of its products. Texts and images present in this catalog have a divulgative purpose and for any technical and dimensional aspect refer at the price list. The colour and material samples have an indicative value.



